

# ANBAUANLEITUNG

mounting instructions • instructions de montage • instrucciones de montaje • istruzioni di montaggio

## **KFT.01.942.65001/B**

beinhaltet • contains • contient • contiene • contiene

KFT.01.942.30001/B

KFT.00.152.36000

HSK.00.745.10001/B

HSK.00.745.11001/B

LOC.00.745.10200

Art.-Nr. / Item No.: **KFT.01.942.30001/B**

Revision: **00** · Datum / Date: **11 - 2020**

**PRO Seitenträger**

**PRO side carrier**

**DEUTSCH** - Vielen Dank, dass Sie sich für dieses Premium-Produkt von SW-MOTECH entschieden haben. Bitte besuchen Sie unseren Webshop für weitere Informationen wie Modellzuweisungen und PDF-Anbauanleitung. Erforderliche Dokumente (z. B. ABE) stehen als Download zur Verfügung.

Die Montage und/oder Wartung dieses Produkts erfordert ein gutes technisches Verständnis! Zu Ihrer eigenen Sicherheit empfiehlt SW-MOTECH, die Montage und/oder Wartung durch eine Fachwerkstatt durchführen zu lassen! SW-MOTECH übernimmt keine Haftung für Schäden, die durch eine unsachgemäße Montage und/oder Wartung verursacht wurden! Beachten Sie alle in der Anbauanleitung angegebenen Hinweise und die für die Montage relevanten Informationen im Fahrzeughandbuch. Nichtbeachtung kann zu Schäden am Fahrzeug bzw. zur Gefährdung des Fahrers führen! Diese Anbauanleitung ist nach unserem derzeitigen Kenntnisstand verfasst worden. Rechtliche Ansprüche auf Richtigkeit bestehen nicht.

Dieses Produkt wurde für Fahrzeuge im Werkzustand entwickelt. Die Kompatibilität mit Original-Zubehörteilen bzw. den Zubehörteilen anderer Hersteller kann nicht gewährleistet werden. Stellen Sie des Weiteren VOR Montage dieses Produkts sicher, dass sich alle beweglichen Teile (z. B. die Kette) im ursprünglichen Wartungszustand befinden. Montiertes Zubehör kann das Fahrverhalten und/oder die Stabilität Ihres Fahrzeugs verändern.

**ALLGEMEINE HINWEISE**



Beachten Sie die landesspezifischen Vorschriften für Zulassung/Betrieb Ihres Fahrzeugs bzw. anwendbare TÜV-Vorschriften. Lassen Sie eintragungspflichtige Teile nach Montage durch Ihre Prüfstelle in die Fahrzeugpapiere eintragen.

**VORBEREITUNG:** Lesen Sie die Anbauanleitung aufmerksam und stellen Sie sicher, dass alle Teile der Stückliste vorhanden sind. Achten Sie darauf, dass Ihr Fahrzeug sicher steht und nicht umfallen kann. Schalten Sie den Motor ab und ziehen Sie den Zündschlüssel. Lassen Sie ggf. den Motor/Auspuff abkühlen. Klemmen Sie bei Arbeiten an der Elektrik die Fahrzeugbatterie ab. Verwenden Sie geeignetes Werkzeug. Lassen Sie sich von einer zweiten Person helfen.

**MONTAGE:** Alle vom Motorrad gelösten Teile und Verbindungen sind gemäß den Fahrzeugherstellereangaben wieder zu montieren oder durch die von SW-MOTECH gelieferten Teile zu ersetzen. Sichern Sie, falls nicht anderweitig definiert, alle Gewinde mit mittelfester, flüssiger Schraubensicherung. **Alle nicht durch SW-MOTECH definierten Anzugsmoment-Vorgaben müssen beim Fahrzeughersteller oder einer Fachwerkstatt erfragt werden!**

**FUNKTIONSKONTROLLE:** Stellen Sie nach der Montage sicher, dass alle zuvor gelösten Teile und Verbindungen wieder ordnungsgemäß montiert wurden. Achten Sie außerdem auf die uneingeschränkte Freigängigkeit und einwandfreie Funktion sämtlicher Fahrzeugteile. Kabel, Züge und Schläuche dürfen nicht scheuern und/oder geklemmt werden. Führen Sie vor Fahrtbeginn eine umfassende Funktionskontrolle durch. Überprüfen Sie nach den ersten 50 km und anschließend in regelmäßigen Abständen das Anzugsmoment aller Schraubverbindungen und den ordnungsgemäßen Sitz des Produkts.

**PRODUKTSPEZIFISCHE HINWEISE**

Maximale Zuladung	Höchstgeschwindigkeit
 <b>12,5 KG (27,5 lbs) /Seite</b>	 <b>130 km/h (80 mph)</b>

**ACHTUNG:** Die angegebene maximale Zuladung beinhaltet das Gewicht von Koffer/Gepäck und Adapterkit! Es gilt die vom Fahrzeughersteller genannte, maximale Zuladung des Fahrzeugs!

Die Seitenträger wurden ausschließlich für die Verwendung von SW-MOTECH Adapterkits konzipiert.

Demontieren Sie die Seitenträger bei Fahrten ohne Gepäck. Benutzen Sie die Seitenträger immer paarweise.

**ACHTUNG:** Achten Sie darauf, dass sich die Koffer nach Montage am Fahrzeug NICHT im Abgasstrom befinden! Verbrennungsgefahr!

**ENGLISH** - Thank you for choosing this premium product from SW-MOTECH. Please visit our webshop for additional information, such as application charts and PDF mounting instructions. Any other documents that may be required (e.g. ABE certifications), are also available for download at our webshop.

Installation and/or maintenance of this product require good technical understanding! For your own safety SW-MOTECH recommends having installation and/or servicing carried out by a specialist workshop! SW-MOTECH assumes no liability for damage caused by improper installation and/or maintenance work!

Carefully follow all the directions given in the mounting instructions and pay attention to all relevant information in the vehicle manual during assembly. Nonconformance can lead to vehicle damage or even endanger the driver! These mounting instructions are written based on our current state of knowledge. Legal requirements for accuracy do not exist.

This product was developed for vehicles in their factory setting. Compatibility with original accessory parts or other manufacturers' accessory parts is not guaranteed. Furthermore, BEFORE installing this product, make sure that all moving parts (e.g. the chain) are in the original state of maintenance. Installed accessories can change the driving behaviour and/or stability of your vehicle.

**GENERAL INFORMATION**

Observe the country-specific regulations concerning vehicle registration/operation as well as TÜV regulations if applicable. If required, register installed parts in the vehicle documents through an appropriate inspection authority.

**PREPARATION:** Read the mounting instructions carefully and make sure that all items of the parts list are included. Make sure that your vehicle is parked safely and cannot fall over. Turn off the engine and remove the ignition key. Let the motor/exhaust cool off if necessary. Disconnect the vehicle battery when working on the electrical system. Use appropriate tools. Have another person to help you.

**MOUNTING:** All parts and connections removed from the vehicle must be reinstalled in accordance with the vehicle manufacturers' specifications or replaced by parts delivered by SW-MOTECH. Secure all threads, unless otherwise specified, with medium-strength liquid thread locker.

**Torque specifications undefined by SW-MOTECH must be obtained from the vehicle manufacturer or by a specialist workshop!**

**FUNCTION CHECK:** After installation make sure that all parts and connections previously removed are properly replaced. Also make sure that no moving parts are obstructed and no function of the vehicle is hindered in any way. Cables and hoses must not rub and/or be pinched. Before starting to ride, perform a comprehensive check of all functions. After the first 50 km and then at regular intervals, check the tightening torque of all screw connections and the proper fit of the product.

**PRODUCT SPECIFIC INFORMATION**

Maximum Load	Maximum Speed
 <b>12.5 KG (27.5 lbs) /side</b>	 <b>130 km/h (80 mph)</b>

**ATTENTION:** The indicated maximum load is inclusive the weight of case / luggage and adapter kit. The maximum vehicle load specified by the manufacturer must not be exceeded!

The side carriers are designed exclusively for the use of SW-MOTECH adapter kits.

Dismount the side carriers when travelling without cases/luggage. Always use the side carriers in pairs.

**ATTENTION:** Make sure that after attaching the luggage to the vehicle it is NOT in the exhaust flow! Dangers of burns!

Konfektionierung durch / Packed by:

Datum der Konfektionierung / Date of packaging:



**SW-MOTECH GmbH & Co. KG**  
Ernteweg 7-10  
35282 Rauschenberg  
Germany

Tel. / phone + 49 (0)6425 / 8168 - 050  
Fax / fax + 49 (0)6425 / 8168 - 10  
**info@sw-motech.com**  
**www.sw-motech.com**

## STÜCKLISTE / PARTS LIST

Schritt Step	Nr. No.	Art.-Nr. / Bezeichnung <sup>a</sup> Item No. / Description <sup>a</sup>	Artikel	Part	Anzahl <sup>b</sup> Quantity <sup>b</sup>	N·m <sup>c</sup>
<b>1</b>	(1)	KFT.01.942.001	Befestigungsglasche	Mounting Tab	4 / 4	
	(2)	M8 x 35; DIN 6912	Innensechskantschraube, fl. Kopf; schwarz	Hexagon Socket Screw, short head; black	4 / 4	18
	(3)	ø 8,4; DIN 125	Unterlegscheibe; schwarz	Washer; black	4 / 4	
	(4)	Ø 18 / ø 8,2 / h 18	Distanzbuchse	Spacer	4 / 4	
<b>2</b>	(5)	KFT.01.942.002	Befestigungsglasche	Mounting Tab	1 / 1	
	(6)	M8 x 30; DIN 912	Innensechskantschraube	Hexagon Socket Screw	2 / 2	20
	(7)	ø 8,4; DIN 125	Unterlegscheibe	Washer	2 / 2	
	(8)	KFT.01.942.003	Befestigungsglasche	Mounting Tab	1 / 1	
	(9)	M6 x 20; DIN 6912	Innensechskantschraube, fl. Kopf; schwarz	Hexagon Socket Screw, short head; black	2 / 2	9
	(10)	ø 6,4; DIN 125	Unterlegscheibe, schwarz	Washer, black	2 / 2	
<b>3</b>	(11)	KFT.01.942.971.01 / 972.01	Seitenträger; links / rechts	Side Carrier; left / right	2 / 2	
	(12)	SV.ST.095.501.LK.02	Schnellverschluss mit Sicherungsscheibe	Quick Fastener with Lock Washer	8 / 8	
	(13)	KFT.01.889.002	Querverbinder	Crossbar	1 / 1	
<b>4</b>	(14)	M6 x 20; DIN 912	Innensechskantschraube	Hexagon Socket Screw	3 / 3	8
	(15)	ø 6,4; DIN 9021	Unterlegscheibe	Washer	6 / 6	
	(16)	Ø 20 / ø 6,4 / h 5	Distanzbuchse	Spacer	1 / 1	
	(17)	M6; DIN 6927	Mutter mit Bund, selbstsichernd	Lock Nut with Flange	3 / 3	

8.8	Regelgewinde / Coarse Thread Ø						N·m	M4	M5	M6	M8	M10	M12	10.9	Regelgewinde / Coarse Thread Ø						N·m	M4	M5	M6	M8	M10	M12
	Stahl FK 8.8 / Steel CL 8.8	2,8	5,5	9,6	23	46									79	Stahl FK 10.9 / Steel CL 10.9	4,1	8,1	14	34							

Anmerkungen: <sup>a</sup> Alle Maßangaben in Millimeter. <sup>b</sup> Der zweite Wert gibt die Gesamtanzahl des jew. Artikels in der Lieferung an. <sup>c</sup> Keine Anzugsmomentvorgabe: Verwenden Sie das vom Fzg.-Hersteller definierte Anzugsmoment! Das Std.-Anzugsmoment der Tabelle kann verwendet werden, wenn es den Fzg.-Hersteller-Vorgaben entspricht.

Note: <sup>a</sup> All measurements in millimeters. <sup>b</sup> The second number indicates the total quantity of the part in the delivery. <sup>c</sup> No torque specifications: Use the torque defined by vehicle manufacturer! The standard torque in this table can be used as long as it is within the vehicle manufacturer's specifications.

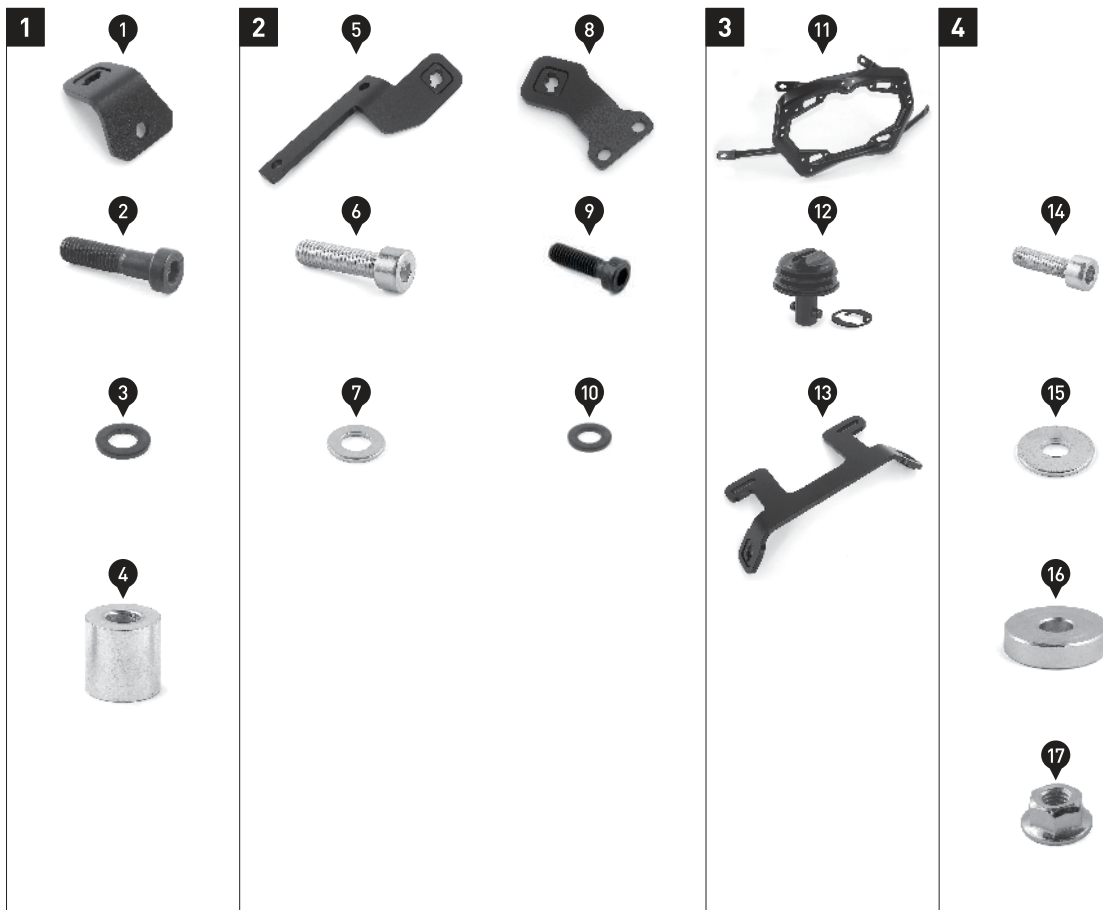

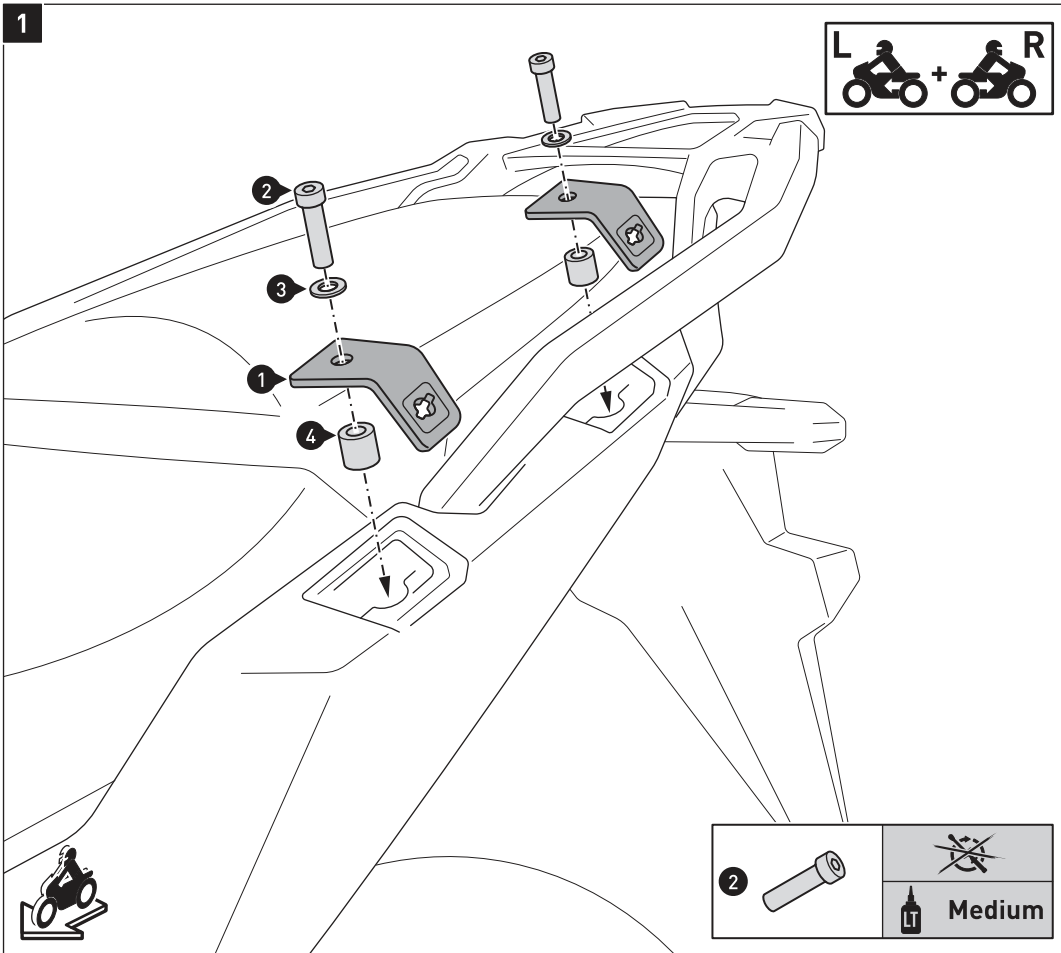

Entfernen Sie die Schrauben auf beiden Seiten des Fahrzeugs von den Anbaupunkten.

Verschrauben Sie die Befestigungslaschen (1) beidseitig am Fahrzeugheck, wie in der Zeichnung gezeigt.  
**ACHTUNG: Verwenden Sie flüssige Schraubensicherung!**  
 Ziehen Sie die Schrauben noch nicht an.

Remove the original screws on both sides of the vehicle from the mounting points.

Attach the mounting tabs (1) on both sides to the rear of the vehicle.  
**ATTENTION: Use liquid thread locker!**  
 Do not fully tighten the screws yet.

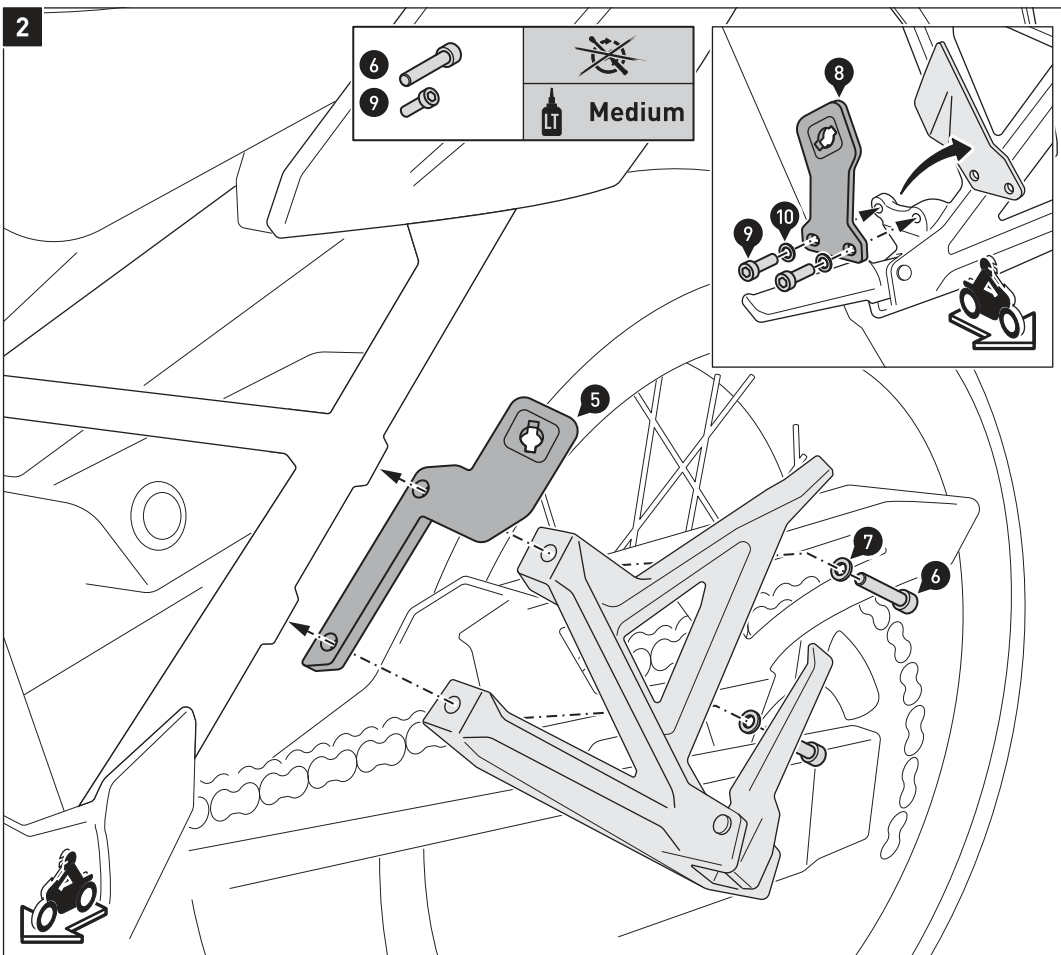

Entfernen Sie auf der linken Fahrzeugseite die Fußraste vom Fahrzeug. Montieren Sie die Befestigungslasche (5) mit der Fußraste am Rahmen, wie in der Zeichnung gezeigt.

**ACHTUNG: Verwenden Sie flüssige Schraubensicherung!**  
 Ziehen Sie die Schrauben noch nicht an.

Lösen Sie auf der rechten Fahrzeugseite den Fersenschutz. Verschrauben Sie die Befestigungslasche (8) an der Sozius-Fußraste, wie in der Detailzeichnung gezeigt.  
**ACHTUNG: Verwenden Sie flüssige Schraubensicherung!**  
 Ziehen Sie die Schrauben noch nicht an.

Remove on the left side the footrest mount from the vehicle. Mount the mounting tab (5) with the footrest mount to the frame, as shown in the drawing.  
**ATTENTION: Use liquid thread locker!**

Do not fully tighten the screws yet. Remove the heel guard on the right side of the vehicle. Attach the mounting tab (8) to the passenger footrest, as shown in the detail drawing.  
**ATTENTION: Use liquid thread locker!**

Do not fully tighten the screws yet.

3

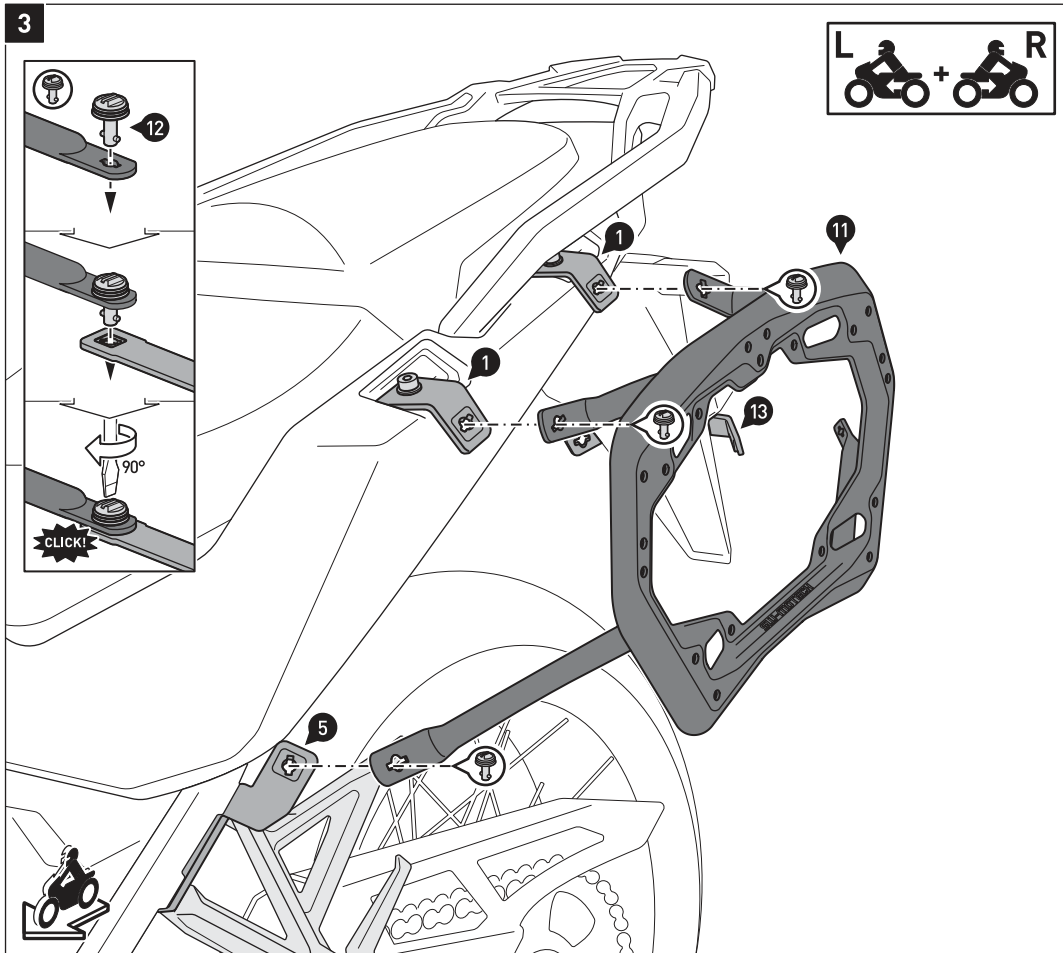

Verbinden Sie die Kofferträger (11) mit den Schnellverschlüssen (12) an den Befestigungslaschen (1) und (5)/(8), sowie dem Querverbinder (13).

Connect the side carriers (11) with the fasteners (12) to the mounting tabs (1) and (5)/(8), as well as the crossbar (13).

4

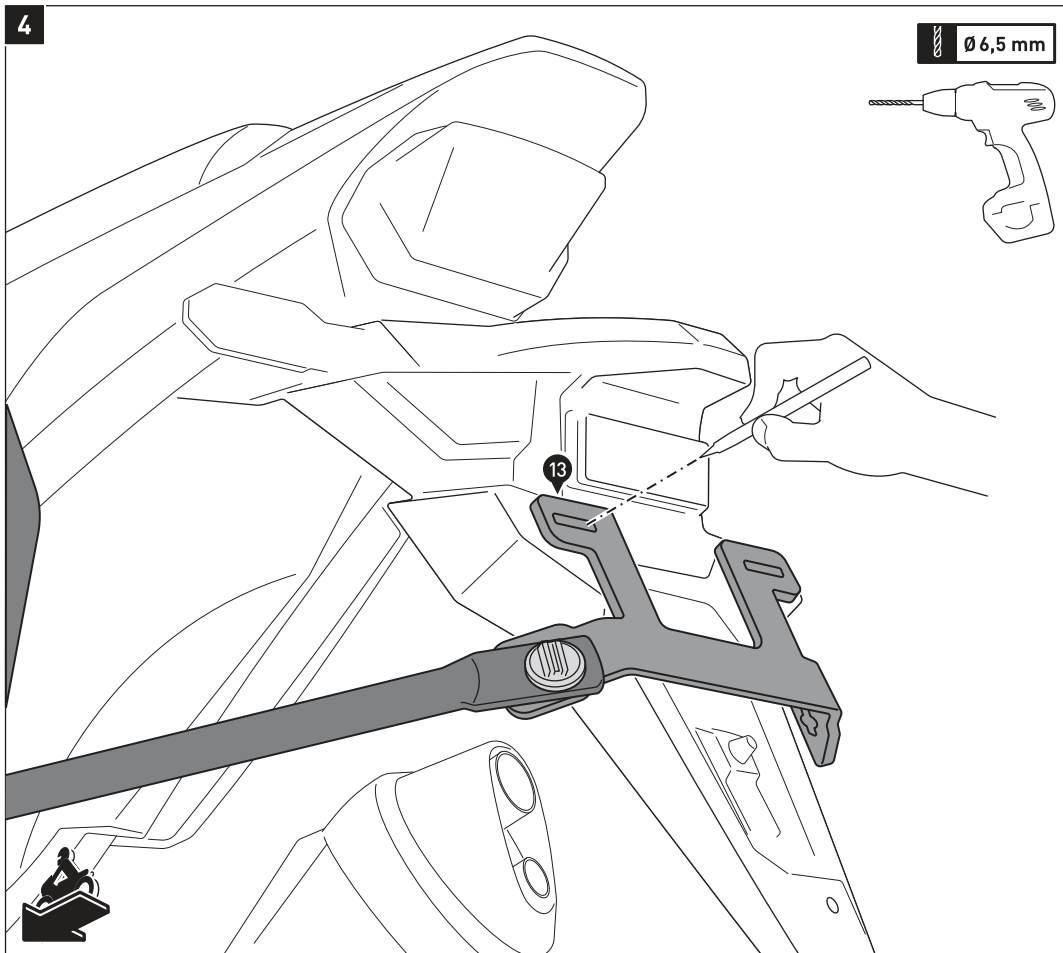

Ø 6,5 mm

Markieren Sie mit einem geeigneten Stift die Befestigungsbohrungen des Querverbinders (13) auf dem Kotflügel.

Lösen Sie anschließend die Schnellverschlüsse (12) und entfernen Sie den Querverbinder (13) und die Kofferträger (11) vom Fahrzeug.

Bohren Sie mit einem 6,5-mm-Bohrer die Befestigungsbohrungen des Querverbinders (13). Entgraten Sie die Ränder der Bohrungen.

Mark with an appropriate pencil the mounting holes of the crossbar (13) on the mudguard.

Then loosen the fasteners (12) and remove the crossbar (13) and side carriers (11).

Use a 6.5-mm drillbit to drill the mounting holes for the crossbar (13). Deburr the edges.

## MONTAGE / MOUNTING

5

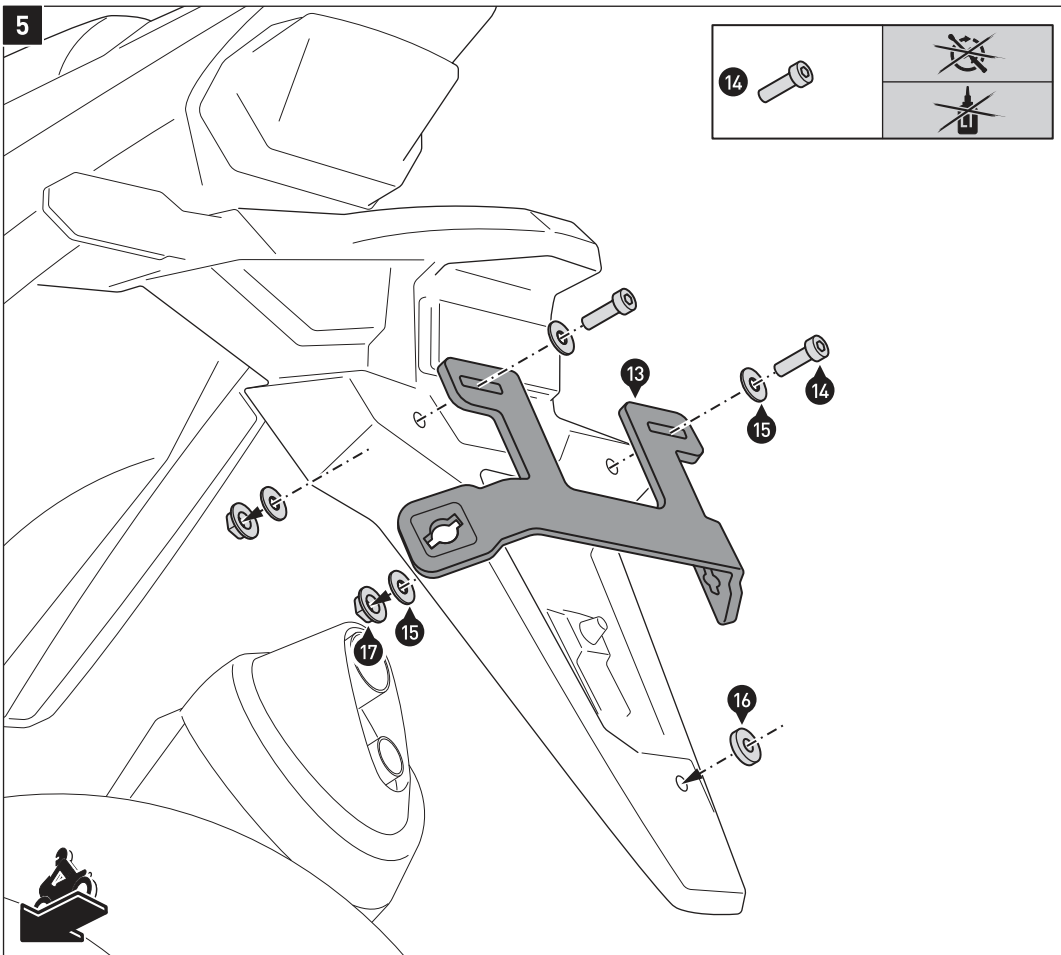

Verschrauben Sie den Querverbin-  
der (13) am Fahrzeug, wie in der  
Zeichnung gezeigt.  
Ziehen Sie die Schrauben noch nicht  
an.

Verwenden Sie die Distanzbuchse  
(16), um den Abstand bei der  
Montage des Nummernschildes  
auszugleichen.

Attach the crossbar (13) to the  
vehicle, as shown in the drawing.  
Do not fully tighten the screws yet.

Use the spacer (16) to compensate  
for the distance when installing the  
license plate.

6

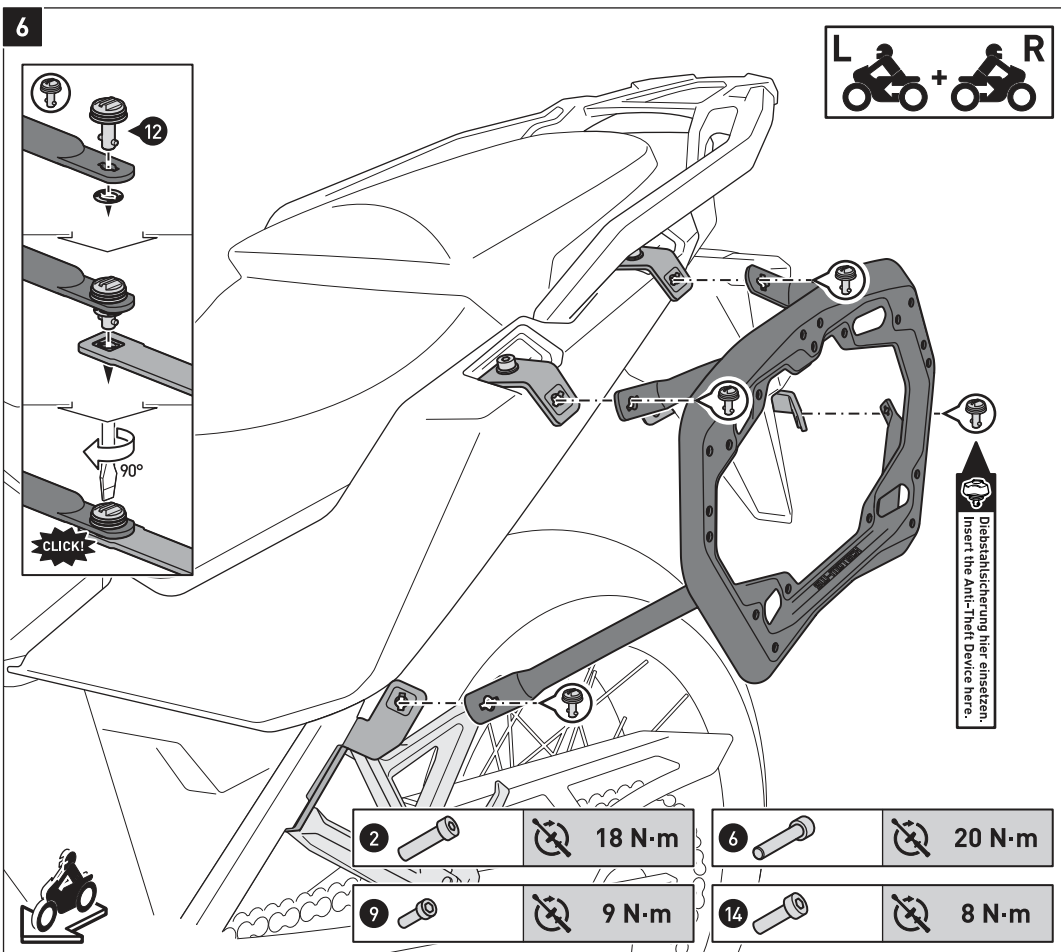

Verbinden Sie die Kofferträger (11)  
mit den Schnellverschlüssen (12) an  
den Befestigungslaschen (1) und  
(5)/(8) und dem Querverbinder (13).  
Sichern Sie die Schnellverschlüsse  
mit den Sicherungsscheiben.

Wenn alle Komponenten  
spannungsfrei sitzen, ziehen Sie die  
Schrauben wie vorgegeben an.

*HINWEIS: Die Diebstahlsicherung ist  
separat erhältlich.*

Connect the side carriers (11) to the  
mounting tabs (1) and (5)/(8) and the  
crossbar (13) with the fasteners  
(12). Secure the fasteners with  
the lock washers.

Once all parts are evenly positioned  
without excess tension, tighten the  
screws as specified.

*NOTE: The Anti-Theft Device is sold  
separately.*

Item number: KFT.00.152.36000

Revision: 00 · Date: 08 - 2023

## Adapter kit for PRO side carrier

 ~ 0.25 h.

EASY      DIFFICULT

**ENGLISH** Thank you for choosing this premium product from SW-MOTECH. Visit our online shop for more information (e.g. model assignments). Required documents (e.g. national type approval) are available there for you to download.

Please read and understand all the instructions, safety information and warnings in these mounting instructions before mounting and using the product in order to avoid injury and damage. Keep these mounting instructions for reference.

This product was developed for vehicles in factory condition. Compatibility with original accessories or accessories from other manufacturers cannot be guaranteed.

These mounting instructions have been prepared to the best of our current knowledge. No legal claims relating to accuracy can be made. Errors and omissions excepted. We reserve the right to make technical and design changes. The copyright is held by SW-MOTECH.

### SAFETY WARNING SYMBOL

 This warning symbol is used in these mounting instructions to warn of deadly dangers, injuries or other hazards. The words **DANGER**, **WARNING** or **CAUTION** are used as part of this warning symbol to convey important safety messages and information relating to the installation and use of this product. These words, together with the safety warning symbol, mean:

 **DANGER:** Indicates a hazardous situation which, if not avoided, will result in death or serious injury!

 **WARNING:** Indicates a hazardous situation which, if not avoided, may result in death or serious injury!

 **CAUTION:** Indicates a hazardous situation which, if not avoided, may result in minor or moderate injury!

 **NOTE:** Important information, but not relating to a risk of death or injury (property damage only)!

### GENERAL INFORMATION

 **WARNING:** Assembly and/or maintenance of this product requires advanced technical skill, appropriate tools, and a good understanding of tool usage and torque specifications. For your own safety, SW-MOTECH recommends having the assembly and/or maintenance carried out by a qualified and certified motorcycle workshop.

 **WARNING:** If you do choose to assemble this product yourself, carefully and fully read the mounting instructions before assembly and use, and follow all instructions to avoid serious injury or death. Also observe all relevant information in the vehicle manual when mounting or using the product. IF YOU DO NOT UNDERSTAND ANY PART OF THESE MOUNTING INSTRUCTIONS OR NEED AN EXPLANATION AS TO A SPECIFIC INSTRUCTION, DO NOT ATTEMPT TO INSTALL THIS PRODUCT WITHOUT CONSULTING SW-MOTECH FOR ASSISTANCE!

**PREPARATION:** Read the mounting instructions carefully and make sure that all parts on the parts list are available.

 **CAUTION:** Ensure that your vehicle is standing securely. Switch off the engine and remove the ignition key. Allow the engine/exhaust to cool down if necessary. Disconnect the battery when working on the electrical system. Only use proper tools and always wear safety goggles and gloves during assembly and maintenance. Have a second person help you with assembly and maintenance.

**ASSEMBLY:** All parts and connections removed from the vehicle must be reinstalled according to the vehicle manufacturer's specifications or replaced with parts and hardware supplied by SW-MOTECH.

 **WARNING:** Secure all threads with a medium-strength liquid threadlocker, unless otherwise specified.

 **DANGER:** Tightening torques not defined by SW-MOTECH must be obtained from the vehicle manufacturer or a certified motorbike workshop.



**FUNCTIONAL CHECK:** After mounting the product, ensure that no moving parts are obstructed and that the function of the vehicle is not impeded. Cables and hoses must not rub against each other and/or be hindered in any way.

 **WARNING:** Carry out a comprehensive functionality check before you start to drive. Check the tightening torque of all connections and the tight fit of the product after the first 50 km and then at regular intervals. Mounted accessories can change the handling and stability of the vehicle.



SW-MOTECH GmbH & Co. KG  
Ernteweg 7-10  
35282 Rauschenberg  
Germany



 [info@sw-motech.com](mailto:info@sw-motech.com)  
 [www.sw-motech.com](http://www.sw-motech.com)



Take note of the symbols and what they mean in the ASSEMBLY section. If the term OEM appears in the ASSEMBLY section, the vehicle manufacturer's specifications must be observed and applied.



If you have any questions, please don't hesitate to contact our Customer Service team or our distributors. You can find our telephone number and a list of our distributors in our online shop:

**[www.sw-motech.com](http://www.sw-motech.com)**



**Do not use thread lock:** Indicates that no liquid thread lock should be used at this point.















**Tighten/note the tightening torque information:**

Indicates the tightening torque of a part specified by SW-MOTECH or the vehicle manufacturer (OEM).



**Use thread locker:** Indicates that a thread must be coated with liquid thread locker. H (HIGH): high strength; M (MEDIUM): medium strength; L (LOW): low strength.

**PARTS LIST - READ AND KEEP MOUNTING INSTRUCTIONS!**

<p><b>1</b></p> 	<p><b>2</b></p> 	<p><b>3</b></p> 	<p><b>4</b></p> 	<p><b>5</b></p> 	<p><b>6</b></p> 
<p>HSK.00.745.025.35GR</p> <p> <b>2/2</b></p>	<p>M6 x 12; ISO 7380 SC.ST.06.012.02.7380.109</p> <p> <b>4/4</b></p>	<p>GPT.00.152.010.35</p> <p> <b>4/4</b></p>	<p>M6 x 25; DIN 7991 SC.ST.06.025.02.7991.088</p> <p> <b>4/4</b></p>	<p>M6; DIN 6927 MU.ST.06.02.6927.08</p> <p> <b>4/4</b></p>	<p>KFT.00.152.026.02</p> <p> <b>8/8</b></p>

1



**⚠ WARNING: Always wear eye and hand protection!**  
**⚠ WARNING: Always use the proper tools!**

**⚠ NOTE:** The illustration shows how to mount on the right PRO side carrier. Follow the same steps with the left PRO side carrier as with the right PRO side carrier.

Screw the parts indicated to your PRO side carriers (sold separately).

**⚠ ATTENTION: Use liquid thread locker (screws 2) only!**  
 Tighten the screws as specified in the mounting instructions.

Then insert the rubber dampeners (6) into the indicated openings.



**PRODUCT-SPECIFIC NOTES**

**⚠ NOTE:** *Observe the country-specific regulations for the registration/operation of your vehicle or applicable TÜV regulations. After assembly, have parts that are subject to registration entered in the vehicle documents by your test centre.*

Item number: HSK.00.745.10001/B

Revision: 00 · Date: 02 - 2025

## DUSC M

 ~ 0.25 h.

EASY      DIFFICULT

**ENGLISH** Thank you for choosing this premium product from SW-MOTECH. Visit our online shop for more information (e.g. model assignments). Required documents (e.g. national type approval) are available there for you to download.

Please read and understand all the instructions, safety information and warnings in these mounting instructions before mounting and using the product in order to avoid injury and damage. Keep these mounting instructions for reference.

This product was developed for vehicles in factory condition. Compatibility with original accessories or accessories from other manufacturers cannot be guaranteed.

These mounting instructions have been prepared to the best of our current knowledge. No legal claims relating to accuracy can be made. Errors and omissions excepted. We reserve the right to make technical and design changes. The copyright is held by SW-MOTECH.

### SAFETY WARNING SYMBOL

 This warning symbol is used in these mounting instructions to warn of deadly dangers, injuries or other hazards. The words **DANGER**, **WARNING** or **CAUTION** are used as part of this warning symbol to convey important safety messages and information relating to the installation and use of this product. These words, together with the safety warning symbol, mean:

 **DANGER:** Indicates a hazardous situation which, if not avoided, will result in death or serious injury!

 **WARNING:** Indicates a hazardous situation which, if not avoided, may result in death or serious injury!

 **CAUTION:** Indicates a hazardous situation which, if not avoided, may result in minor or moderate injury!

 **NOTE:** Important information, but not relating to a risk of death or injury (property damage only)!

### GENERAL INFORMATION

 **WARNING:** Assembly and/or maintenance of this product requires advanced technical skill, appropriate tools, and a good understanding of tool usage and torque specifications. For your own safety, SW-MOTECH recommends having the assembly and/or maintenance carried out by a qualified and certified motorcycle workshop.

 **WARNING:** If you do choose to assemble this product yourself, carefully and fully read the mounting instructions before assembly and use, and follow all instructions to avoid serious injury or death. Also observe all relevant information in the vehicle manual when mounting or using the product. IF YOU DO NOT UNDERSTAND ANY PART OF THESE MOUNTING INSTRUCTIONS OR NEED AN EXPLANATION AS TO A SPECIFIC INSTRUCTION, DO NOT ATTEMPT TO INSTALL THIS PRODUCT WITHOUT CONSULTING SW-MOTECH FOR ASSISTANCE!

**PREPARATION:** Read the mounting instructions carefully and make sure that all parts on the parts list are available.

 **CAUTION:** Ensure that your vehicle is standing securely. Switch off the engine and remove the ignition key. Allow the engine/exhaust to cool down if necessary. Disconnect the battery when working on the electrical system. Only use proper tools and always wear safety goggles and gloves during assembly and maintenance. Have a second person help you with assembly and maintenance.

**ASSEMBLY:** All parts and connections removed from the vehicle must be reinstalled according to the vehicle manufacturer's specifications or replaced with parts and hardware supplied by SW-MOTECH.

 **WARNING:** Secure all threads with a medium-strength liquid threadlocker, unless otherwise specified.

 **DANGER:** Tightening torques not defined by SW-MOTECH must be obtained from the vehicle manufacturer or a certified motorbike workshop.



**FUNCTIONAL CHECK:** After mounting the product, ensure that no moving parts are obstructed and that the function of the vehicle is not impeded. Cables and hoses must not rub against each other and/or be hindered in any way.

 **WARNING:** Carry out a comprehensive functionality check before you start to drive. Check the tightening torque of all connections and the tight fit of the product after the first 50 km and then at regular intervals. Mounted accessories can change the handling and stability of the vehicle.



SW-MOTECH GmbH & Co. KG  
Ernteweg 7-10  
35282 Rauschenberg  
Germany



 [info@sw-motech.com](mailto:info@sw-motech.com)  
 [www.sw-motech.com](http://www.sw-motech.com)

**LEGEND OVERVIEW - READ AND KEEP MOUNTING INSTRUCTIONS!**



Take note of the symbols and what they mean in the ASSEMBLY section. If the term OEM appears in the ASSEMBLY section, the vehicle manufacturer's specifications must be observed and applied.



If you have any questions, please don't hesitate to contact our Customer Service team or our distributors. You can find our telephone number and a list of our distributors in our online shop:

**[www.sw-motech.com](http://www.sw-motech.com)**



**Do not use thread lock:** Indicates that no liquid thread lock should be used at this point.



**Tighten by hand:** Indicates that the attachment must be carefully tightened by hand.

**PARTS LIST - READ AND KEEP MOUNTING INSTRUCTIONS!**

**1**

**1**



HSK.00.745.80000/B

 **1/1**

**2**

**2**



HSK.00.745.027.02

 **2/2**

**3**

**3**



HSK.00.745.047.02

 **1/1**

**4**



4 x 10; WN 1452  
SC.ST.040.010.48.1452.109

 **2/2**

**5**



T20  
TRX.T20

 **1/1**

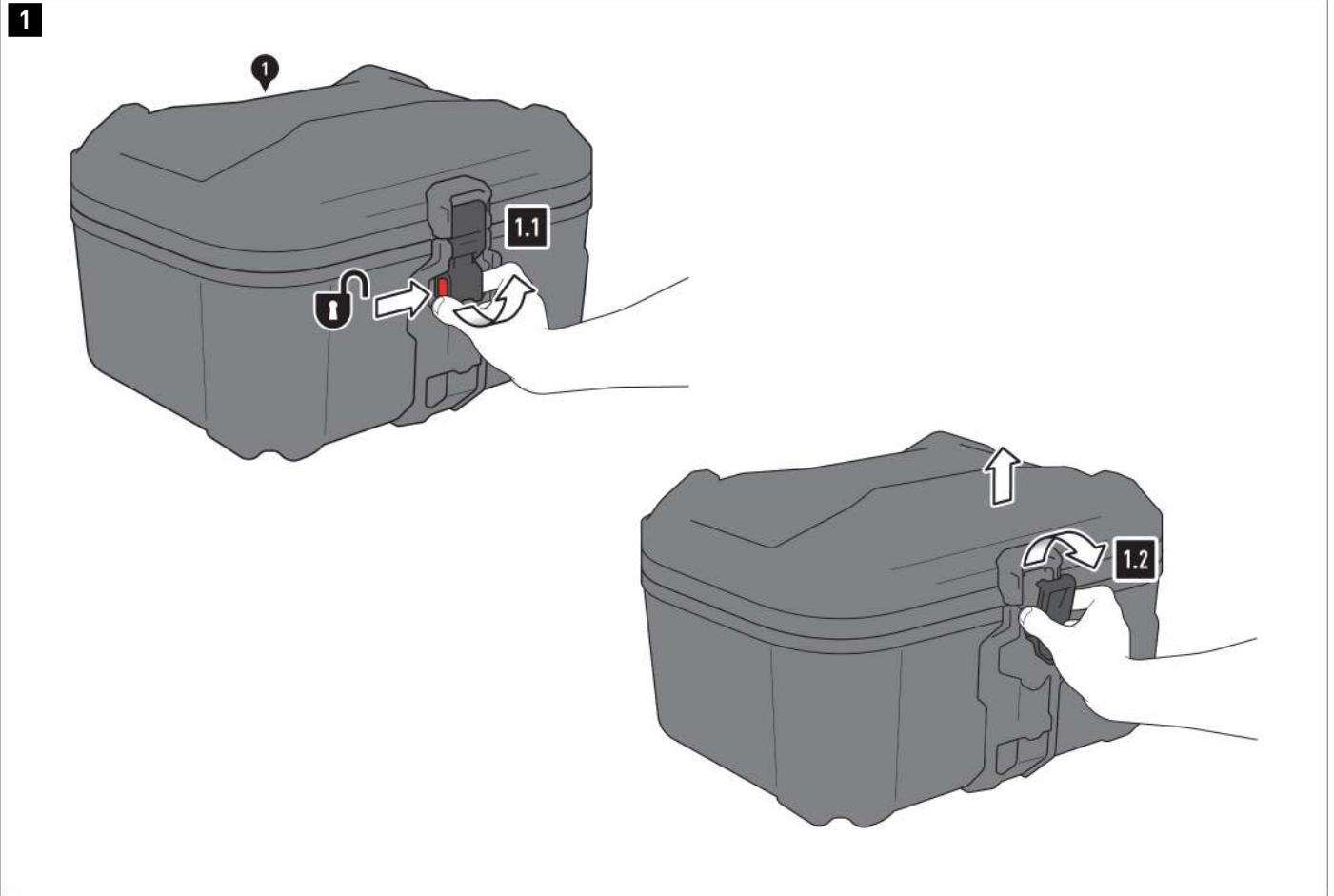

- ⚠ **WARNING: Always wear eye and hand protection!**
- ⚠ **WARNING: Always use the proper tools!**

**Opening the lid**

- 1.1 - Press the DUSC release button (1) and pull the lid latch buckle to the open position.
- 1.2 - Remove the latch buckle from the corresponding bracket and open the lid.

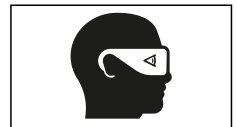

2

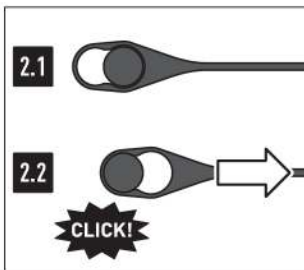
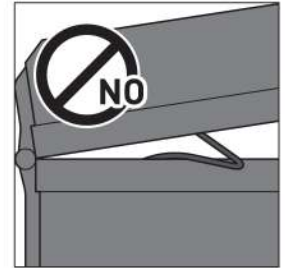
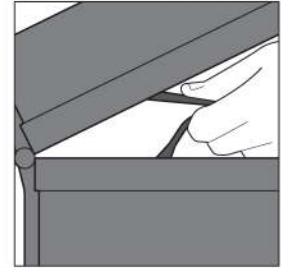

**Installing the lid limiter**

2.1 - Place the lid limiters (2) with the large openings on the mushroom-shaped supports provided

**⚠ NOTE:** Pay attention to the proper use of the DUSC (1): **top case** or **side case**. Fasten the lid limiters (2) to the respective mushroom-shaped DUSC (1).

2.2 - Pull the lid limiters (2) into fixed position.

**⚠ NOTE:** Before closing the lid for the first time, the lid limiters (2) must be slightly compressed. When closing the lid, make sure that the lid limiters (2) are not trapped between the lid and the case body.

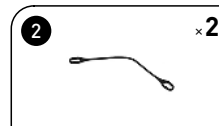

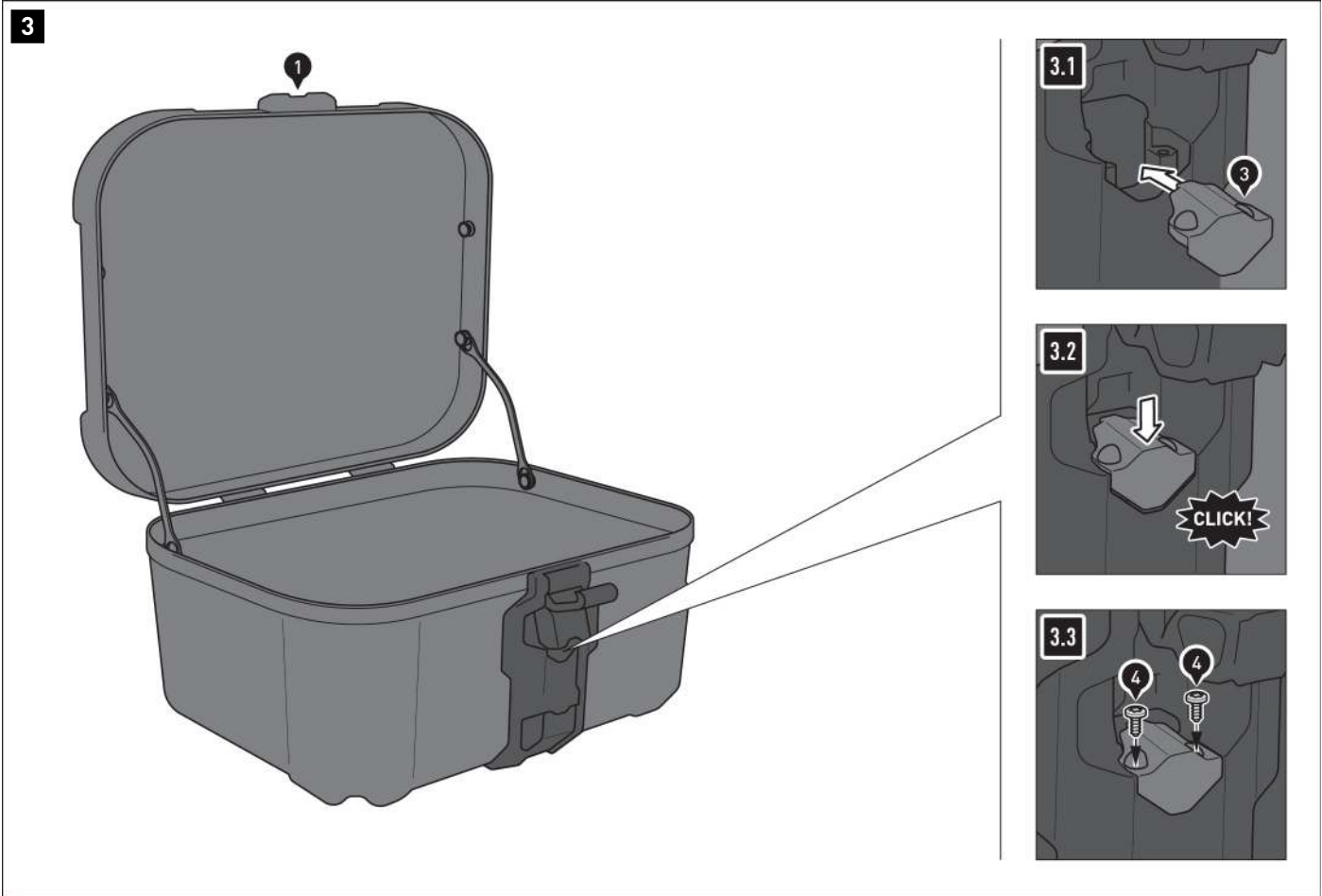

**Installing lock casing connector**

**⚠ NOTE:** If you have opted for the DUSC lock set, this step is not necessary. Install the lock set instead.

**3.1** - Open the DUSC latch buckle (1) and position the latch housing connector (3) as shown.

**3.2** - Push the latch housing connector (3) down until it clicks into place.

**3.3** - Screw in the latch housing connector (3) using the screws (4) and the torx key (5). Carefully tighten the screws by hand.

**⚠ WARNING:** Over-tightening the screws may damage the lock casing!

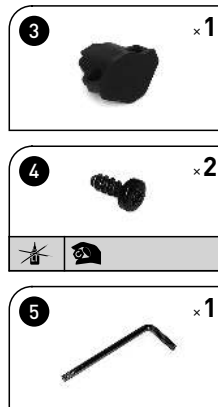



#### Attaching the DUSC to a top case

**⚠ NOTE:** Prior to fastening, ensure that the lock (DUSC lock set) is in the open position (if applicable); see detailed drawings on the left!

**4.1** - Press the DUSC release button (1) and pull the fastening system latch buckle to the open position.

**4.2** - Press the DUSC (1) with the two locking openings onto the mushroom-shaped supports of your SW-MOTECH rack.

**4.3** - Press the DUSC (1) with the locking opening onto the locking lug of your SW-MOTECH rack.

**4.4** - Press the system latch buckle to closed position.

**⚠ WARNING:** You should be able to hear a clicking sound!

**⚠ WARNING:** Check that the DUSC is firmly in place! Make sure that the latch buckle is flush with the latch buckle case!

**⚠ WARNING:** Make sure that no components of the DUSC (1) can come into contact with any hot and moving parts on the vehicle!  
 Also ensure that all components are at least 5 cm away from hot parts as well as hot gas coming from the exhaust!  
 After assembly, make sure that this distance is maintained in all vehicle positions!



**Attaching the DUSC to a side case**

**▲ NOTE:** Prior to fastening, ensure that the lock (DUSC lock set) is in the open position (if applicable); see detailed drawings on the left!

**5.1** - Press the DUSC release button (1) and pull the system latch buckle to the open position.

**5.2** - Slide the DUSC (1) with the two locking openings onto the mushroom-shaped supports of your SW-MOTECH side carrier.

**5.3** - Press the DUSC (1) with the locking opening onto the locking lug of your SW-MOTECH side carrier.

**5.4** - Press the system latch buckle to closed position.

**▲ WARNING: Make sure you hear it clicking into place!**

**▲ WARNING: Check that the DUSC is firmly in place! Make sure that the latch buckle is flush with the latch buckle case!**

**▲ WARNING: Make sure that no components of the DUSC (1) can come into contact with any hot and moving parts on the vehicle! Also ensure that all components are at least 5 cm away from hot parts as well as hot gas coming from the exhaust! After assembly, make sure that this distance is maintained in all vehicle positions!**

6

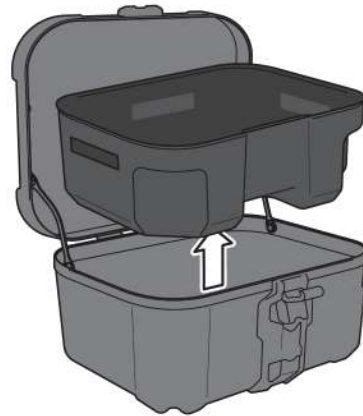
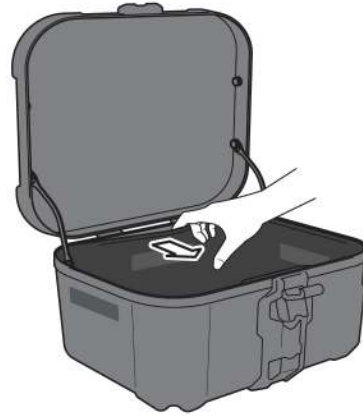

#### Removing the inlays

The DUSC comes with mounted inlays as standard. They can be removed if needed (e. g. for cleaning, see "Care" section). Use a blunt object (e. g. a butter knife) to push out the **case lid inlay** that is stuck behind the frame profile; then remove the inlay from the case lid. Remove the **inlay in the case body** from the Velcro strips on the side; then take the inlay out of the case body.

When reassembling the inlays, make sure to carefully push them behind the frame profiles. Also, press the inlay in the case body onto the Velcro strips.

7



#### Loading the DUSC

**▲ WARNING: Ensure that the load is evenly distributed! Ensure that the load will not slip while driving!**

**▲ NOTE: Make sure that you never store sharp-edged, pointy or similar objects that could cause injury to persons or damage to the vehicle/DUSC!** Be particularly careful not to damage the overpressure membrane built into the lid!

#### Caring for DUSC / inlays

For cleaning, use **ONLY** a soft textile brush, cloth or sponge and warm soapy water! Then rinse with clean water.

**Do NOT** use any harsh cleaning agents, abrasive cleaning utensils or pressure washer!

Be sure to clean the DUSC after winter driving to avoid salt damage.

**▲ NOTE: Surface materials may be subject to fluctuations in color (fading) in the event of prolonged and intensive exposure to sunlight and the elements (e.g. smog, acid rain, etc.)! SW-MOTECH is not responsible for this type of wear!**

PRODUCT-SPECIFIC NOTES

**⚠ NOTE:** Observe the country-specific regulations for registering/operating your vehicle or the applicable TÜV regulations. After assembly, have parts that are subject to registration entered in the vehicle documents by your test centre.

**⚠ DANGER:** Carry out a comprehensive function check before driving!

**⚠ DANGER:** Check that the product is properly positioned before departure and at every rest stop (every 200 km)!

**⚠ DANGER:** The driving/braking behavior of the motorcycle changes noticeably after the attachment of this product!

**⚠ DANGER:** Lean angle and ground clearance may be restricted by this product!

**⚠ DANGER:** The maximum vehicle load defined by the vehicle manufacturer may NOT be exceeded.  
The maximum permissible load of the SW-MOTECH rack/side rack may NOT be exceeded; make sure to take into account the dead weight of the product.

Dead weight DUSC M (with inlays): 4.7 kg (10.4 lbs)

Dead weight DUSC L (with inlays): 5.0 kg (11.0 lbs)

Dead weight DUSC M (without inlays): 3.9 kg (8.6 lbs)

Dead weight DUSC L (without inlays): 4.1 kg (9.0 lbs)

Payload when used as a top case:

 ≤ 5 kg (≤ 11 lbs)	 ≤ 130km/h (≤ 80mph)
--	--

Payload when used as a side case:

 ≤ 10KG (≤ 22 lbs)	 ≤ 130km/h (≤ 80mph)
---	---

Item number: HSK.00.745.11001/B

Revision: 00 · Date: 02 - 2025

## DUSC L

 ~ 0.25 h.

EASY      DIFFICULT

**ENGLISH** Thank you for choosing this premium product from SW-MOTECH. Visit our online shop for more information (e.g. model assignments). Required documents (e.g. national type approval) are available there for you to download.

Please read and understand all the instructions, safety information and warnings in these mounting instructions before mounting and using the product in order to avoid injury and damage. Keep these mounting instructions for reference.

This product was developed for vehicles in factory condition. Compatibility with original accessories or accessories from other manufacturers cannot be guaranteed.

These mounting instructions have been prepared to the best of our current knowledge. No legal claims relating to accuracy can be made. Errors and omissions excepted. We reserve the right to make technical and design changes. The copyright is held by SW-MOTECH.

### SAFETY WARNING SYMBOL

 This warning symbol is used in these mounting instructions to warn of deadly dangers, injuries or other hazards. The words DANGER, WARNING or CAUTION are used as part of this warning symbol to convey important safety messages and information relating to the installation and use of this product. These words, together with the safety warning symbol, mean:

 **DANGER:** Indicates a hazardous situation which, if not avoided, will result in death or serious injury!

 **WARNING:** Indicates a hazardous situation which, if not avoided, may result in death or serious injury!

 **CAUTION:** Indicates a hazardous situation which, if not avoided, may result in minor or moderate injury!

 **NOTE:** Important information, but not relating to a risk of death or injury (property damage only)!

### GENERAL INFORMATION

 **WARNING:** Assembly and/or maintenance of this product requires advanced technical skill, appropriate tools, and a good understanding of tool usage and torque specifications. For your own safety, SW-MOTECH recommends having the assembly and/or maintenance carried out by a qualified and certified motorcycle workshop.

 **WARNING:** If you do choose to assemble this product yourself, carefully and fully read the mounting instructions before assembly and use, and follow all instructions to avoid serious injury or death. Also observe all relevant information in the vehicle manual when mounting or using the product. IF YOU DO NOT UNDERSTAND ANY PART OF THESE MOUNTING INSTRUCTIONS OR NEED AN EXPLANATION AS TO A SPECIFIC INSTRUCTION, DO NOT ATTEMPT TO INSTALL THIS PRODUCT WITHOUT CONSULTING SW-MOTECH FOR ASSISTANCE!

**PREPARATION:** Read the mounting instructions carefully and make sure that all parts on the parts list are available.

 **CAUTION:** Ensure that your vehicle is standing securely. Switch off the engine and remove the ignition key. Allow the engine/exhaust to cool down if necessary. Disconnect the battery when working on the electrical system. Only use proper tools and always wear safety goggles and gloves during assembly and maintenance. Have a second person help you with assembly and maintenance.

**ASSEMBLY:** All parts and connections removed from the vehicle must be reinstalled according to the vehicle manufacturer's specifications or replaced with parts and hardware supplied by SW-MOTECH.

 **WARNING:** Secure all threads with a medium-strength liquid threadlocker, unless otherwise specified.

 **DANGER:** Tightening torques not defined by SW-MOTECH must be obtained from the vehicle manufacturer or a certified motorbike workshop.

**FUNCTIONAL CHECK:** After mounting the product, ensure that no moving parts are obstructed and that the function of the vehicle is not impeded. Cables and hoses must not rub against each other and/or be hindered in any way.

 **WARNING:** Carry out a comprehensive functionality check before you start to drive. Check the tightening torque of all connections and the tight fit of the product after the first 50 km and then at regular intervals. Mounted accessories can change the handling and stability of the vehicle.



SW-MOTECH GmbH & Co. KG  
Ernteweg 7-10  
35282 Rauschenberg  
Germany



[info@sw-motech.com](mailto:info@sw-motech.com)  
[www.sw-motech.com](http://www.sw-motech.com)

**LEGEND OVERVIEW - READ AND KEEP MOUNTING INSTRUCTIONS!**



Take note of the symbols and what they mean in the ASSEMBLY section. If the term OEM appears in the ASSEMBLY section, the vehicle manufacturer's specifications must be observed and applied.



If you have any questions, please don't hesitate to contact our Customer Service team or our distributors. You can find our telephone number and a list of our distributors in our online shop:

**[www.sw-motech.com](http://www.sw-motech.com)**



**Do not use thread lock:** Indicates that no liquid thread lock should be used at this point.



**Tighten by hand:** Indicates that the attachment must be carefully tightened by hand.

**PARTS LIST - READ AND KEEP MOUNTING INSTRUCTIONS!**

**1**

**1**



HSK.00.745.80000/B

 **1/1**

**2**

**2**



HSK.00.745.027.02

 **2/2**

**3**

**3**



HSK.00.745.047.02

 **1/1**

**4**



4 x 10; WN 1452  
SC.ST.040.010.48.1452.109

 **2/2**

**5**



T20  
TRX.T20

 **1/1**

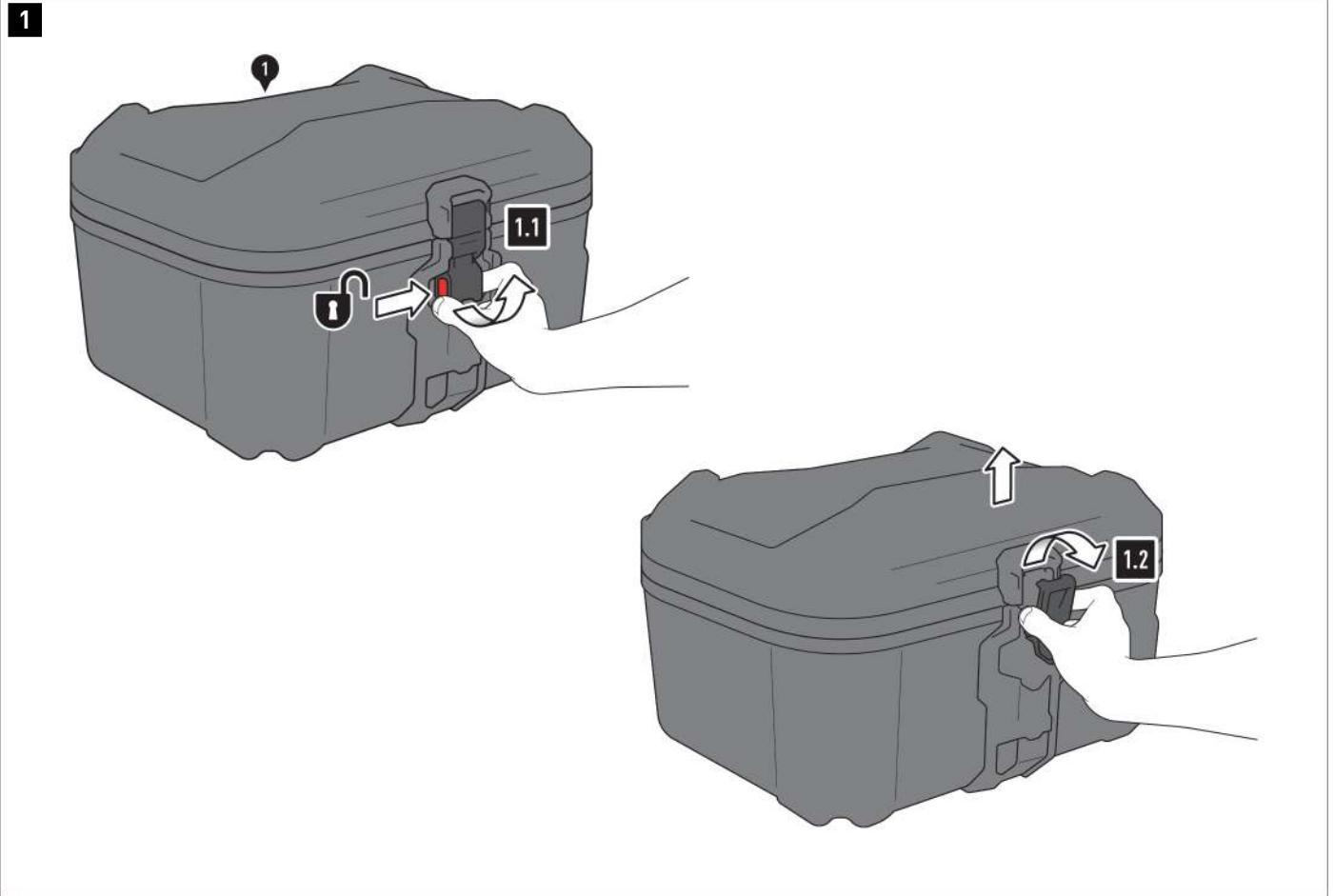

- ⚠ **WARNING: Always wear eye and hand protection!**
- ⚠ **WARNING: Always use the proper tools!**

**Opening the lid**

- 1.1 - Press the DUSC release button (1) and pull the lid latch buckle to the open position.
- 1.2 - Remove the latch buckle from the corresponding bracket and open the lid.

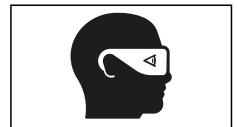

2

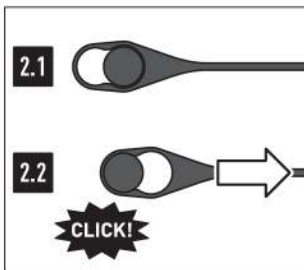
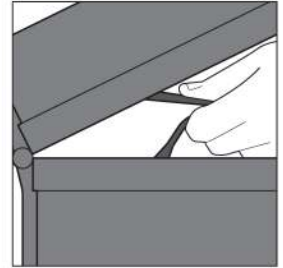
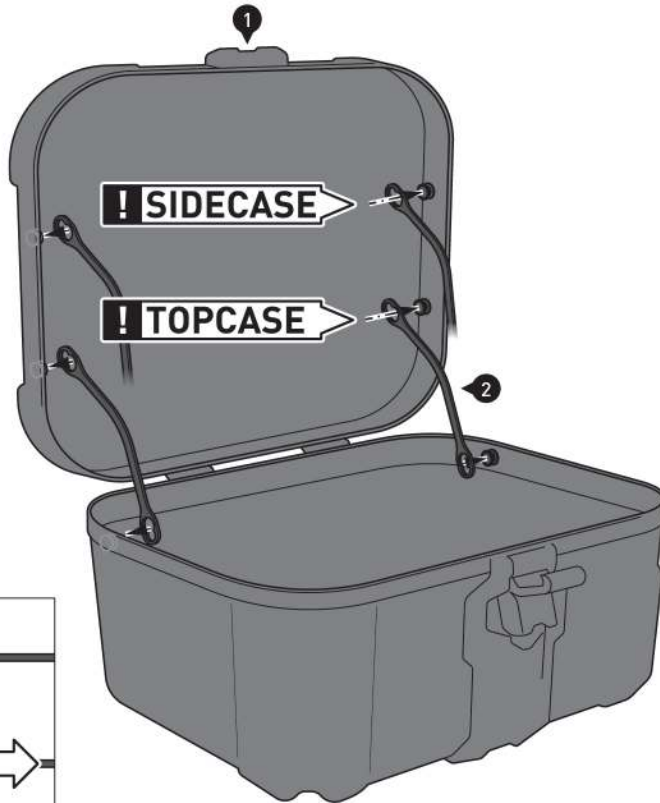

**Installing the lid limiter**

**2.1** - Place the lid limiters (2) with the large openings on the mushroom-shaped supports provided

**⚠ NOTE:** Pay attention to the proper use of the DUSC (1): **top case** or **side case**. Fasten the lid limiters (2) to the respective mushroom-shaped DUSC (1).

**2.2** - Pull the lid limiters (2) into fixed position.

**⚠ NOTE:** Before closing the lid for the first time, the lid limiters (2) must be slightly compressed. When closing the lid, make sure that the lid limiters (2) are not trapped between the lid and the case body.

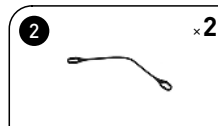

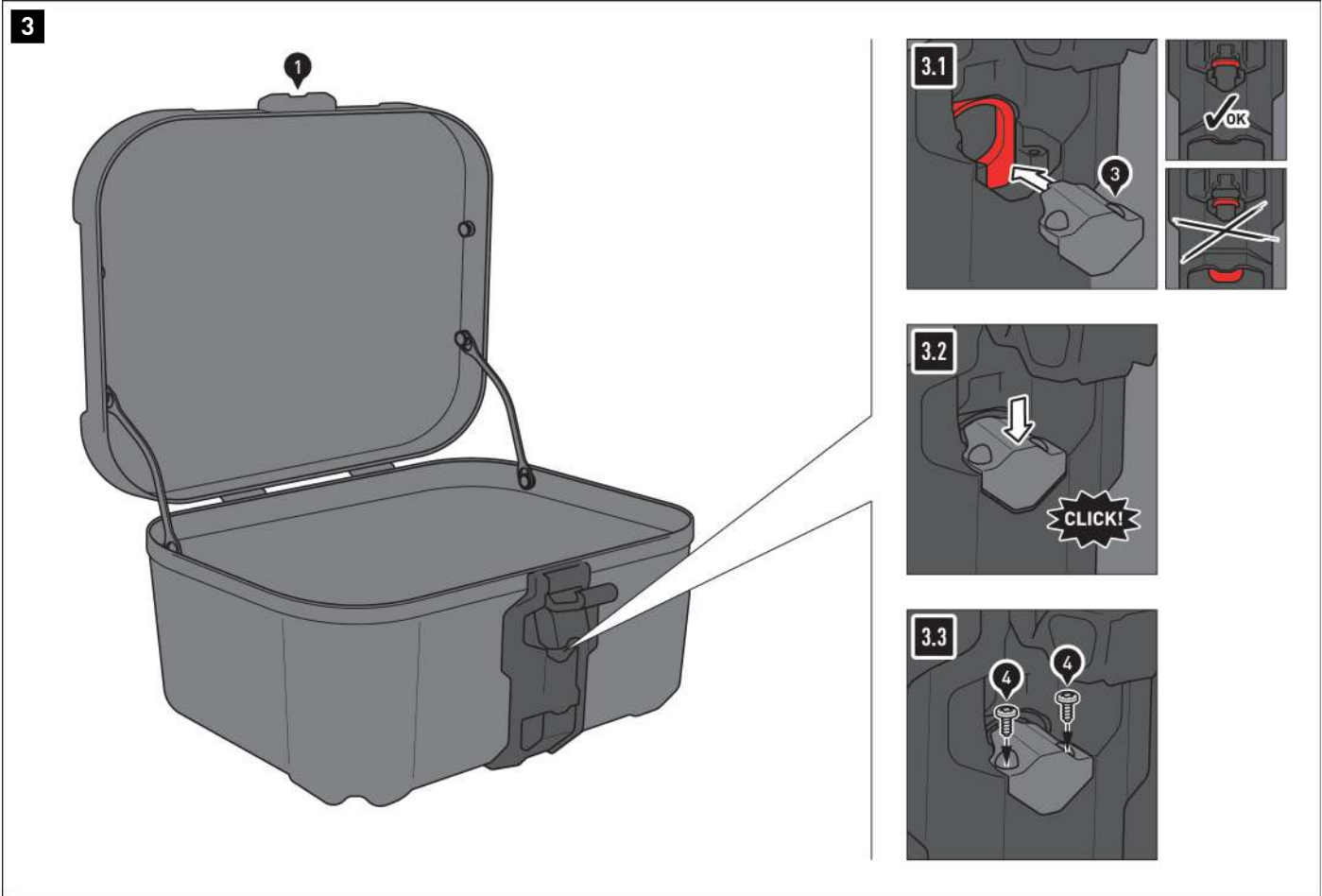

**Installing lock casing connector**

**⚠ NOTE:** If you have opted for the DUSC lock set, this step is not necessary. Install the lock set instead.

**3.1 -** Open the DUSC latch buckle (1) and position the latch housing connector (3) as shown.

**⚠ NOTE:** Make sure the locking tab is in the unlocked (up) position. If necessary, the locking tab must be pushed up into the unlocked position.

**3.2 -** Push the latch housing connector (3) down until it clicks into place.

**3.3 -** Screw in the latch housing connector (3) using the screws (4) and the torx key (5). Carefully tighten the screws by hand.

**⚠ WARNING:** Over-tightening the screws may damage the lock casing!

**⚠ NOTE:** Ensure that the locking mechanism is in working order!

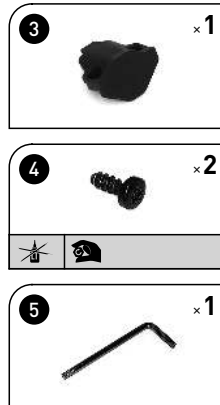

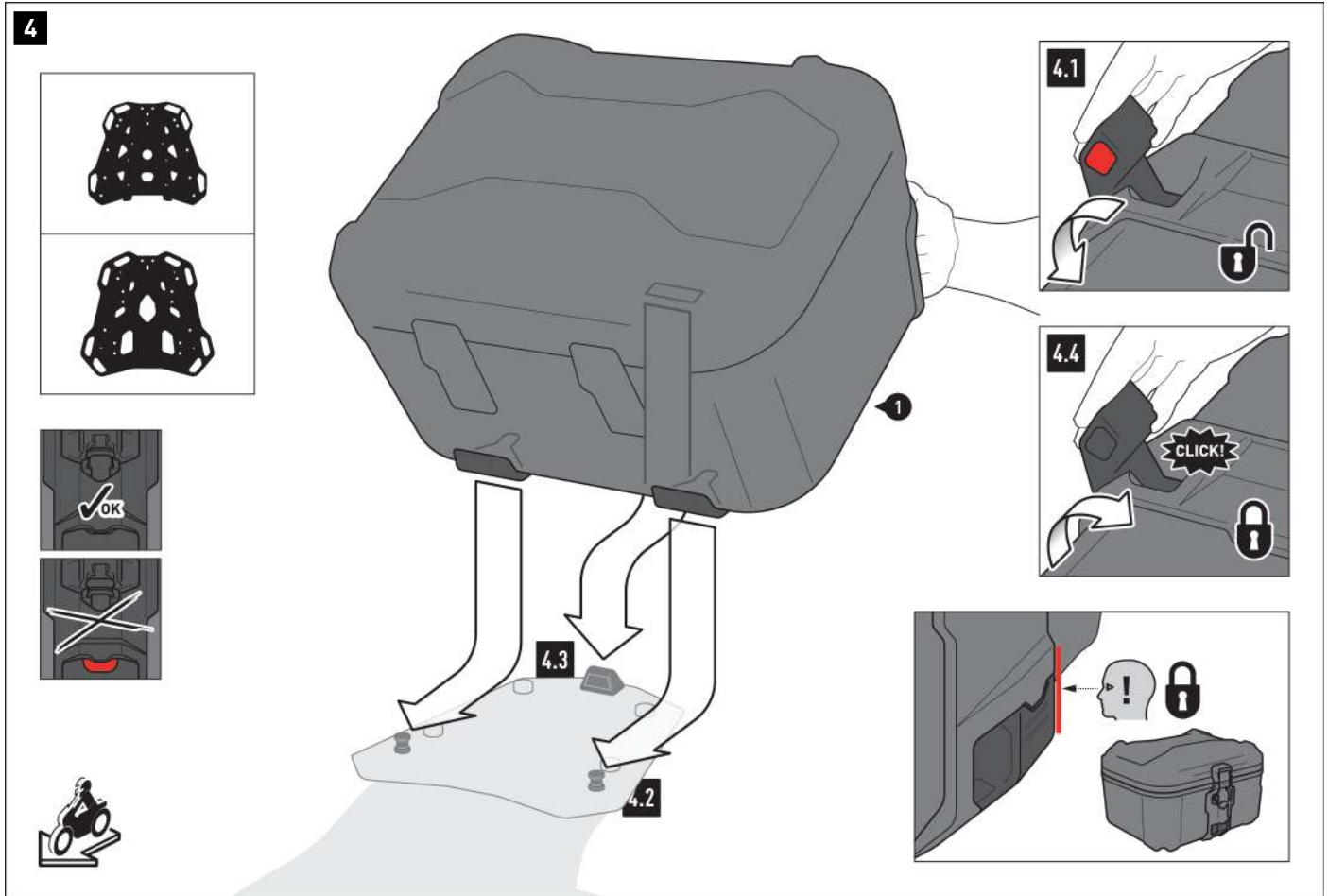

**Attaching the DUSC to a top case**

**⚠ NOTE:** Prior to fastening, ensure that the lock (DUSC lock set) is in the open position (if applicable); see detailed drawings on the left!

**4.1** - Press the DUSC release button (1) and pull the fastening system latch buckle to the open position.

**4.2** - Press the DUSC (1) with the two locking openings onto the mushroom-shaped supports of your SW-MOTECH rack.

**4.3** - Press the DUSC (1) with the locking opening onto the locking lug of your SW-MOTECH rack.

**4.4** - Press the system latch buckle to closed position.

**⚠ WARNING:** You should be able to hear a clicking sound!

**⚠ WARNING:** Check that the DUSC is firmly in place! Make sure that the latch buckle is flush with the latch buckle case!

**⚠ WARNING:** Make sure that no components of the DUSC (1) can come into contact with any hot and moving parts on the vehicle!  
 Also ensure that all components are at least 5 cm away from hot parts as well as hot gas coming from the exhaust!  
 After assembly, make sure that this distance is maintained in all vehicle positions!

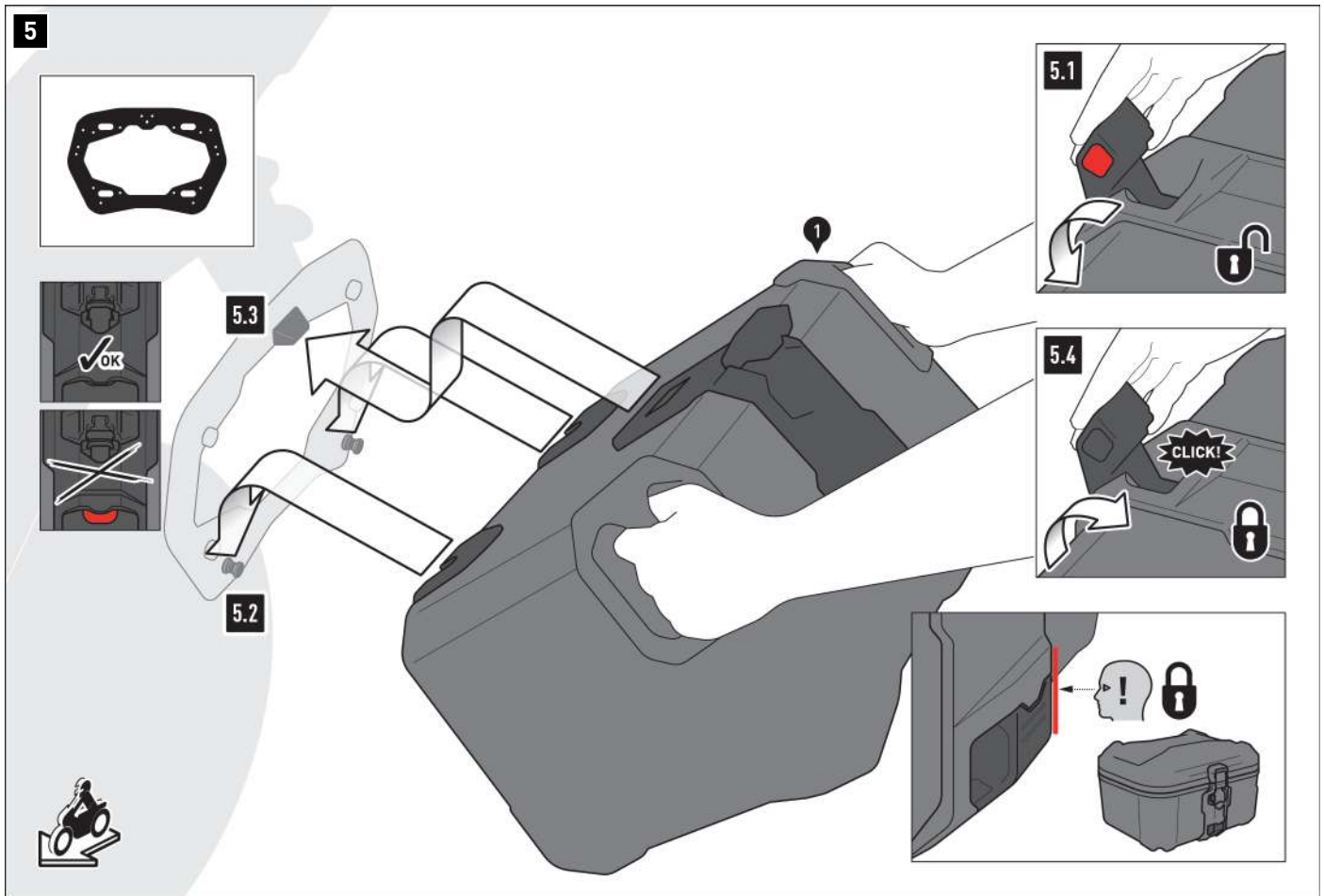

**Attaching the DUSC to a side case**

**▲ NOTE:** Prior to fastening, ensure that the lock (DUSC lock set) is in the open position (if applicable); see detailed drawings on the left!

**5.1** - Press the DUSC release button (1) and pull the system latch buckle to the open position.

**5.2** - Slide the DUSC (1) with the two locking openings onto the mushroom-shaped supports of your SW-MOTECH side carrier.

**5.3** - Press the DUSC (1) with the locking opening onto the locking lug of your SW-MOTECH side carrier.

**5.4** - Press the system latch buckle to closed position.

**▲ WARNING:** Make sure you hear it clicking into place!

**▲ WARNING:** Check that the DUSC is firmly in place! Make sure that the latch buckle is flush with the latch buckle case!

**▲ WARNING:** Make sure that no components of the DUSC (1) can come into contact with any hot and moving parts on the vehicle!  
 Also ensure that all components are at least 5 cm away from hot parts as well as hot gas coming from the exhaust!  
 After assembly, make sure that this distance is maintained in all vehicle positions!

6

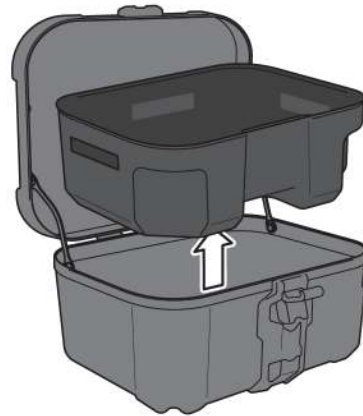
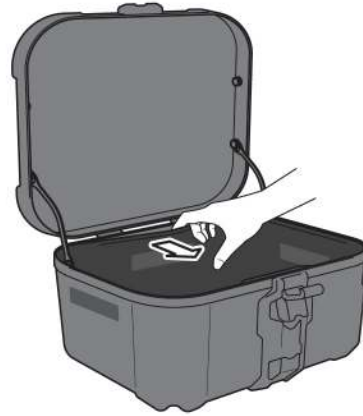

#### Removing the inlays

The DUSC comes with mounted inlays as standard. They can be removed if needed (e. g. for cleaning, see "Care" section). Use a blunt object (e. g. a butter knife) to push out the **case lid inlay** that is stuck behind the frame profile; then remove the inlay from the case lid. Remove the **inlay in the case body** from the Velcro strips on the side; then take the inlay out of the case body.

When reassembling the inlays, make sure to carefully push them behind the frame profiles. Also, press the inlay in the case body onto the Velcro strips.

7

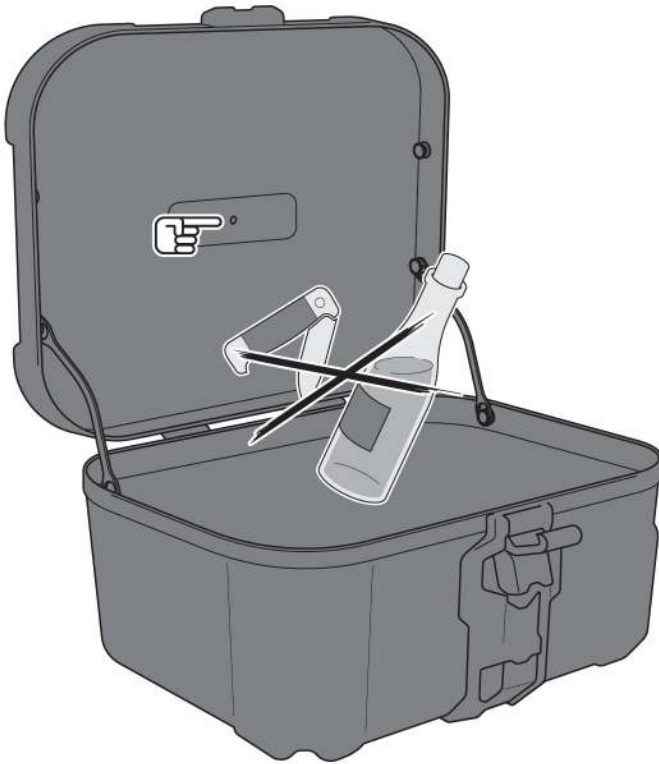

**Loading the DUSC**

**▲ WARNING: Ensure that the load is evenly distributed! Ensure that the load will not slip while driving!**

**▲ NOTE: Make sure that you never store sharp-edged, pointy or similar objects that could cause injury to persons or damage to the vehicle/DUSC!** Be particularly careful not to damage the overpressure membrane built into the lid!

**Caring for DUSC / inlays**

For cleaning, use **ONLY** a soft textile brush, cloth or sponge and warm soapy water! Then rinse with clean water.

**Do NOT** use any harsh cleaning agents, abrasive cleaning utensils or pressure washer!

Be sure to clean the DUSC after winter driving to avoid salt damage.

**▲ NOTE: Surface materials may be subject to fluctuations in color (fading) in the event of prolonged and intensive exposure to sunlight and the elements (e.g. smog, acid rain, etc.)! SW-MOTECH is not responsible for this type of wear!**

PRODUCT-SPECIFIC NOTES

**⚠ NOTE:** Observe the country-specific regulations for registering/operating your vehicle or the applicable TÜV regulations. After assembly, have parts that are subject to registration entered in the vehicle documents by your test centre.

**⚠ DANGER:** Carry out a comprehensive function check before driving!

**⚠ DANGER:** Check that the product is properly positioned before departure and at every rest stop (every 200 km)!

**⚠ DANGER:** The driving/braking behavior of the motorcycle changes noticeably after the attachment of this product!

**⚠ DANGER:** Lean angle and ground clearance may be restricted by this product!

**⚠ DANGER:** The maximum vehicle load defined by the vehicle manufacturer may NOT be exceeded.  
The maximum permissible load of the SW-MOTECH rack/side rack may NOT be exceeded; make sure to take into account the dead weight of the product.

Dead weight DUSC M (with inlays): 4.7 kg (10.4 lbs)  
Dead weight DUSC L (with inlays): 5.0 kg (11.0 lbs)

Dead weight DUSC M (without inlays): 3.9 kg (8.6 lbs)  
Dead weight DUSC L (without inlays): 4.1 kg (9.0 lbs)

Payload when used as a top case:

 ≤ 5 kg (≤ 11 lbs)	 ≤ 130km/h (≤ 80mph)
--	--

Payload when used as a side case:

 ≤ 10KG (≤ 22 lbs)	 ≤ 130km/h (≤ 80mph)
---	---

Item number: **LOC.00.745.10200**

Revision: **00** · Date: **08 - 2023**

## Hard case lock set

 ~ 0.25 h.

EASY      DIFFICULT

**ENGLISH** Thank you for choosing this premium product from SW-MOTECH. Visit our online shop for more information (e.g. model assignments). Required documents (e.g. national type approval) are available there for you to download.

**Please read and understand all the instructions, safety information and warnings in these mounting instructions before mounting and using the product in order to avoid injury and damage. Keep these mounting instructions for reference.**

**This product was developed for vehicles in factory condition. Compatibility with original accessories or accessories from other manufacturers cannot be guaranteed.**

**These mounting instructions have been prepared to the best of our current knowledge. No legal claims relating to accuracy can be made. Errors and omissions excepted. We reserve the right to make technical and design changes. The copyright is held by SW-MOTECH.**

### SAFETY WARNING SYMBOL

 This warning symbol is used in these mounting instructions to warn of deadly dangers, injuries or other hazards. The words **DANGER**, **WARNING** or **CAUTION** are used as part of this warning symbol to convey important safety messages and information relating to the installation and use of this product. These words, together with the safety warning symbol, mean:

 **DANGER:** Indicates a hazardous situation which, if not avoided, will result in death or serious injury!

 **WARNING:** Indicates a hazardous situation which, if not avoided, may result in death or serious injury!

 **CAUTION:** Indicates a hazardous situation which, if not avoided, may result in minor or moderate injury!

 **NOTE:** Important information, but not relating to a risk of death or injury (property damage only)!

### GENERAL INFORMATION

 **WARNING:** Assembly and/or maintenance of this product requires advanced technical skill, appropriate tools, and a good understanding of tool usage and torque specifications. For your own safety, SW-MOTECH recommends having the assembly and/or maintenance carried out by a qualified and certified motorcycle workshop.

 **WARNING:** If you do choose to assemble this product yourself, carefully and fully read the mounting instructions before assembly and use, and follow all instructions to avoid serious injury or death. Also observe all relevant information in the vehicle manual when mounting or using the product. **IF YOU DO NOT UNDERSTAND ANY PART OF THESE MOUNTING INSTRUCTIONS OR NEED AN EXPLANATION AS TO A SPECIFIC INSTRUCTION, DO NOT ATTEMPT TO INSTALL THIS PRODUCT WITHOUT CONSULTING SW-MOTECH FOR ASSISTANCE!**

**PREPARATION:** Read the mounting instructions carefully and make sure that all parts on the parts list are available.

 **CAUTION:** Ensure that your vehicle is standing securely. Switch off the engine and remove the ignition key. Allow the engine/exhaust to cool down if necessary. Disconnect the battery when working on the electrical system. Only use proper tools and always wear safety goggles and gloves during assembly and maintenance. Have a second person help you with assembly and maintenance.

**ASSEMBLY:** All parts and connections removed from the vehicle must be reinstalled according to the vehicle manufacturer's specifications or replaced with parts and hardware supplied by SW-MOTECH.

 **WARNING:** Secure all threads with a medium-strength liquid threadlocker, unless otherwise specified.

 **DANGER:** Tightening torques not defined by SW-MOTECH must be obtained from the vehicle manufacturer or a certified motorbike workshop.



**FUNCTIONAL CHECK:** After mounting the product, ensure that no moving parts are obstructed and that the function of the vehicle is not impeded. Cables and hoses must not rub against each other and/or be hindered in any way.

 **WARNING:** Carry out a comprehensive functionality check before you start to drive. Check the tightening torque of all connections and the tight fit of the product after the first 50 km and then at regular intervals. Mounted accessories can change the handling and stability of the vehicle.



SW-MOTECH GmbH & Co. KG  
Ernteweg 7-10  
35282 Rauschenberg  
Germany



 [info@sw-motech.com](mailto:info@sw-motech.com)  
 [www.sw-motech.com](http://www.sw-motech.com)



Take note of the symbols and what they mean in the ASSEMBLY section. If the term OEM appears in the ASSEMBLY section, the vehicle manufacturer's specifications must be observed and applied.



If you have any questions, please don't hesitate to contact our Customer Service team or our distributors. You can find our telephone number and a list of our distributors in our online shop:

**[www.sw-motech.com](http://www.sw-motech.com)**

**PARTS LIST - READ AND KEEP MOUNTING INSTRUCTIONS!**

**2**

**1**



HSK.00.745.500.04

 **3/3**

**2**



T20  
TRX.T20

 **1/1**

**3**



ALK.00.165.A63

 **2/2**

**3**

**3**



ALK.00.165.562.01

 **1/1**

**4**

**5**



QLS.00.095.520.01

 **2/2**

**6**



SV.ST.095.007.LK.02

 **2/2**

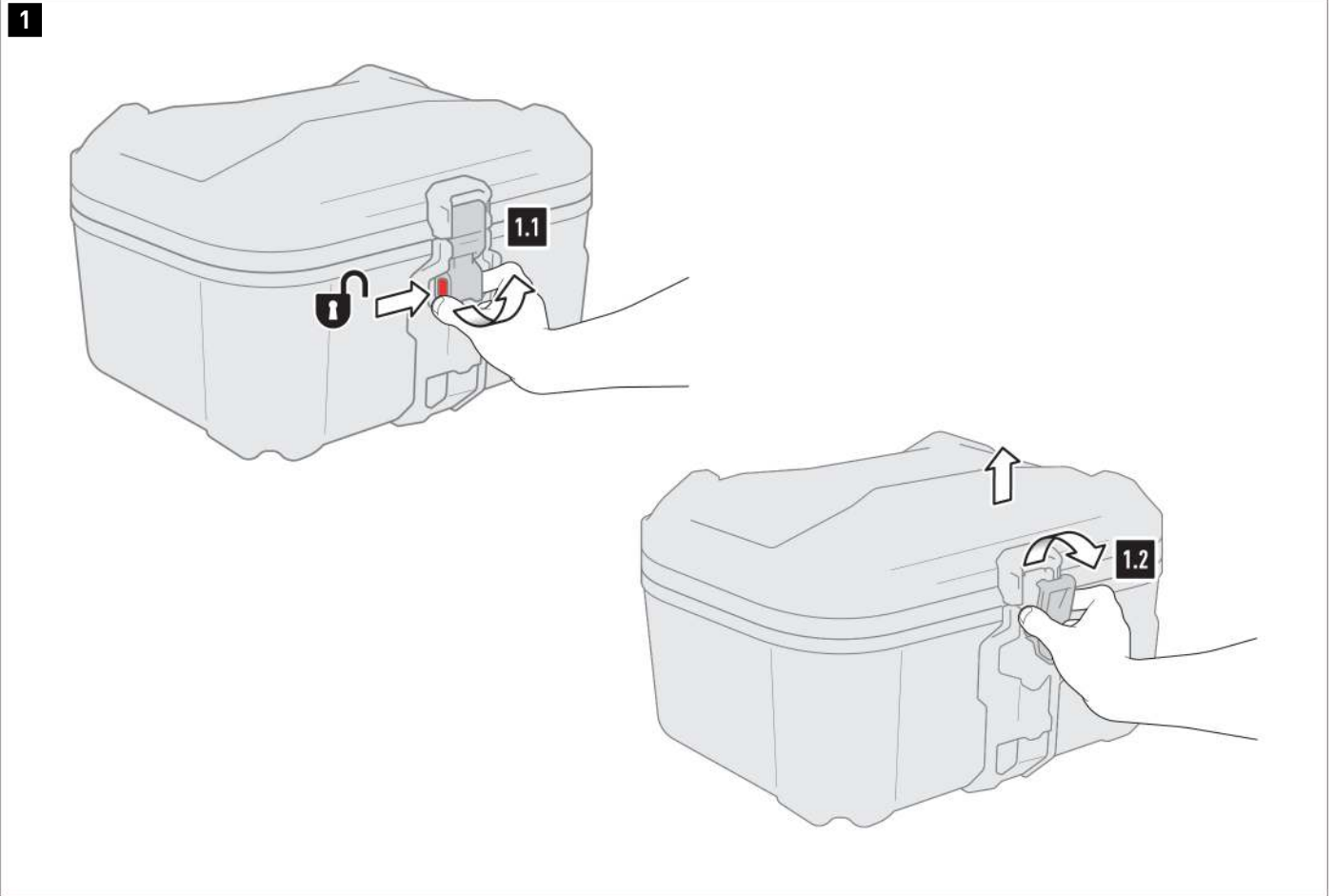

- ⚠ **WARNING: Always wear eye and hand protection!**
- ⚠ **WARNING: Always use the proper tools!**

**Opening the lid**

1.1 - Press the DUSC release button (\*) and pull the lid latch buckle into the open position.

1.2 - Remove the latch buckle from the corresponding bracket and open the lid.

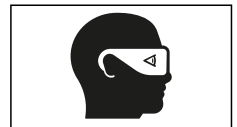

2

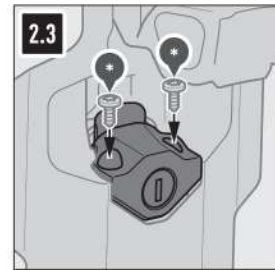
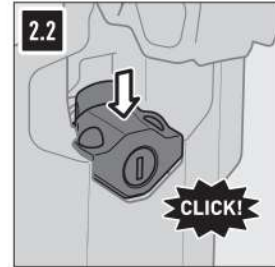
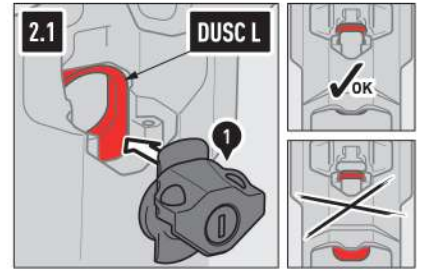

**Install DUSC lock**

**2.1** - Open the DUSC (\*) latch buckle and position the lock (1) as shown.  
 ⚠ **NOTE: DUSC L ONLY:** Make sure the locking tab (highlighted in red) is in the unlocked position (up)! If necessary, the locking tab must be pushed up into the unlocked position!

**2.2** - Push the lock (1) down until it clicks into place.

**2.3** - Screw in the lock (1) using the screws (\*) supplied with the DUSC and the torx key (2). Carefully tighten the screws by hand.

⚠ **WARNING: Over-tightening the screws may damage the lock casing!**

⚠ **NOTE:** Ensure that the locking mechanism is in working order!

⚠ **NOTE:** NEVER lubricate the lock cylinder with oil! Only use graphite powder!



3

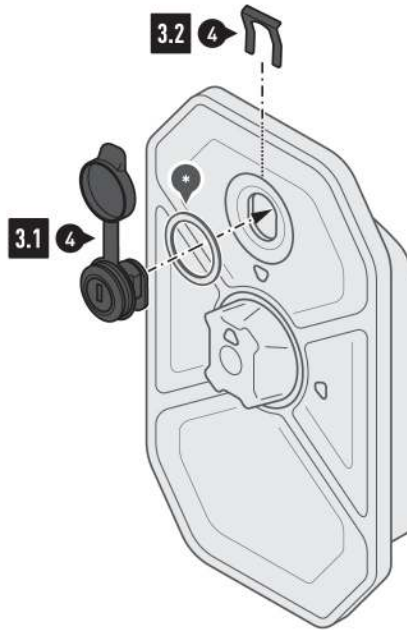

**Install toolbox lock**

**3.1** - Insert the lock (4) with the sealing ring (\*) supplied with the toolbox in the lock hole of the cover. Secure the lock (4) on the inside with the safety clip (4)



**⚠ NOTE:** NEVER lubricate the lock cylinder with oil! Only use graphite powder!

4

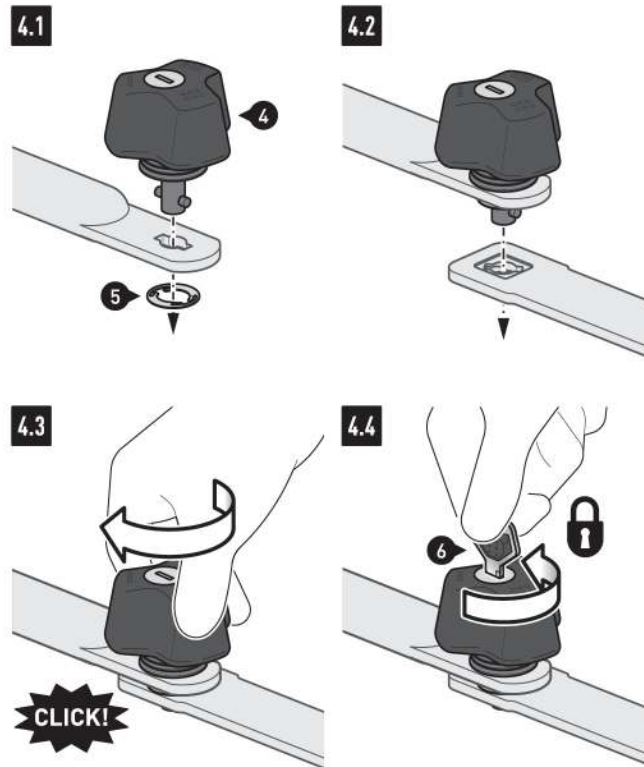

**Mount anti-theft protection device for PRO side carrier**

**4.1** - Insert the anti-theft protection device (5) into the side carrier opening defined in the side carrier mounting instructions. Secure the anti-theft protection device (5) with the lock washer (6).

**4.2** - Now insert the anti-theft protection device (5) in the opening of the side support fastener ...

**4.3** - ... and turn the anti-theft protection device (5) until it engages.

**4.4** - Then the anti-theft protection device (5) must be secured against unscrewing.

**⚠ NOTE:** NEVER lubricate the lock cylinder with oil! Only use graphite powder!



**PRODUCT-SPECIFIC NOTES**

**⚠ NOTE:** *Observe the country-specific regulations for the registration/operation of your vehicle or applicable TÜV regulations. After assembly, have parts that are subject to registration entered in the vehicle documents by your test centre.*