

ANBAUANLEITUNG

mounting instructions • instructions de montage • instrucciones de montaje • istruzioni di montaggio

FRS.01.011.10600/B

beinhaltet • contains • contient • contiene • contiene

FRS.01.011.80600/B

FRS.00.011.10000/B

Item number: **FRS.01.011.80600/B**

Revision: **00** · Date: **03 - 2025**

Mounting kit for ION footrest

 ~ 0.75 h.

EASY     DIFFICULT

ENGLISH Thank you for choosing this premium product from SW-MOTECH. Visit our online shop for more information (e.g. model assignments). Required documents (e.g. national type approval) are available there for you to download.

Please read and understand all the instructions, safety information and warnings in these mounting instructions before mounting and using the product in order to avoid injury and damage. Keep these mounting instructions for reference.

This product was developed for vehicles in factory condition. Compatibility with original accessories or accessories from other manufacturers cannot be guaranteed.

These mounting instructions have been prepared to the best of our current knowledge. No legal claims relating to accuracy can be made. Errors and omissions excepted. We reserve the right to make technical and design changes. The copyright is held by SW-MOTECH.

SAFETY WARNING SYMBOL

 This warning symbol is used in these mounting instructions to warn of deadly dangers, injuries or other hazards. The words **DANGER**, **WARNING** or **CAUTION** are used as part of this warning symbol to convey important safety messages and information relating to the installation and use of this product. These words, together with the safety warning symbol, mean:

 **DANGER:** Indicates a hazardous situation which, if not avoided, will result in death or serious injury!

 **WARNING:** Indicates a hazardous situation which, if not avoided, may result in death or serious injury!

 **CAUTION:** Indicates a hazardous situation which, if not avoided, may result in minor or moderate injury!

 **NOTE:** Important information, but not relating to a risk of death or injury (property damage only)!

GENERAL INFORMATION

 **WARNING:** Assembly and/or maintenance of this product requires advanced technical skill, appropriate tools, and a good understanding of tool usage and torque specifications. For your own safety, SW-MOTECH recommends having the assembly and/or maintenance carried out by a qualified and certified motorcycle workshop.

 **WARNING:** If you do choose to assemble this product yourself, carefully and fully read the mounting instructions before assembly and use, and follow all instructions to avoid serious injury or death. Also observe all relevant information in the vehicle manual when mounting or using the product. **IF YOU DO NOT UNDERSTAND ANY PART OF THESE MOUNTING INSTRUCTIONS OR NEED AN EXPLANATION AS TO A SPECIFIC INSTRUCTION, DO NOT ATTEMPT TO INSTALL THIS PRODUCT WITHOUT CONSULTING SW-MOTECH FOR ASSISTANCE!**

PREPARATION: Read the mounting instructions carefully and make sure that all parts on the parts list are available.

 **CAUTION:** Ensure that your vehicle is standing securely. Switch off the engine and remove the ignition key. Allow the engine/exhaust to cool down if necessary. Disconnect the battery when working on the electrical system. Only use proper tools and always wear safety goggles and gloves during assembly and maintenance. Have a second person help you with assembly and maintenance.

ASSEMBLY: All parts and connections removed from the vehicle must be reinstalled according to the vehicle manufacturer's specifications or replaced with parts and hardware supplied by SW-MOTECH.

 **WARNING:** Secure all threads with a medium-strength liquid threadlocker, unless otherwise specified.

 **DANGER:** Tightening torques not defined by SW-MOTECH must be obtained from the vehicle manufacturer or a certified motorbike workshop.

FUNCTIONAL CHECK: After mounting the product, ensure that no moving parts are obstructed and that the function of the vehicle is not impeded. Cables and hoses must not rub against each other and/or be hindered in any way.

 **WARNING:** Carry out a comprehensive functionality check before you start to drive. Check the tightening torque of all connections and the tight fit of the product after the first 50 km and then at regular intervals. Mounted accessories can change the handling and stability of the vehicle.



SW-MOTECH GmbH & Co. KG
Ernteweg 7-10
35282 Rauschenberg
Germany



info@sw-motech.com
www.sw-motech.com

LEGEND OVERVIEW - READ AND KEEP MOUNTING INSTRUCTIONS!



Take note of the symbols and what they mean in the ASSEMBLY section. If the term OEM appears in the ASSEMBLY section, the vehicle manufacturer's specifications must be observed and applied.



If you have any questions, please don't hesitate to contact our Customer Service team or our distributors. You can find our telephone number and a list of our distributors in our online shop:

www.sw-motech.com



Use thread locker: Indicates that a thread must be coated with liquid thread locker. H (HIGH): high strength; M (MEDIUM): medium strength; L (LOW): low strength.



Tighten/note the tightening torque information:

Indicates the tightening torque of a part specified by SW-MOTECH or the vehicle manufacturer (OEM).

PARTS LIST - READ AND KEEP MOUNTING INSTRUCTIONS!

2

1



FRS.01.011.A23R.25

 **1/1**

2



FRS.01.011.A23L.25

 **1/1**

3



M8 x 16; DIN 933
SC.ST.08.016.01.933.109

 **2/2**

4



∅ 8,4; DIN 9021
US.ST.084.01.9021.300

 **2/2**

5



M6 x 12; DIN 913
GEW.00.06.012.01.913

 **2/2**

6



M6; DIN 1587
MU.ST.06.01.1587.06

 **2/2**

1

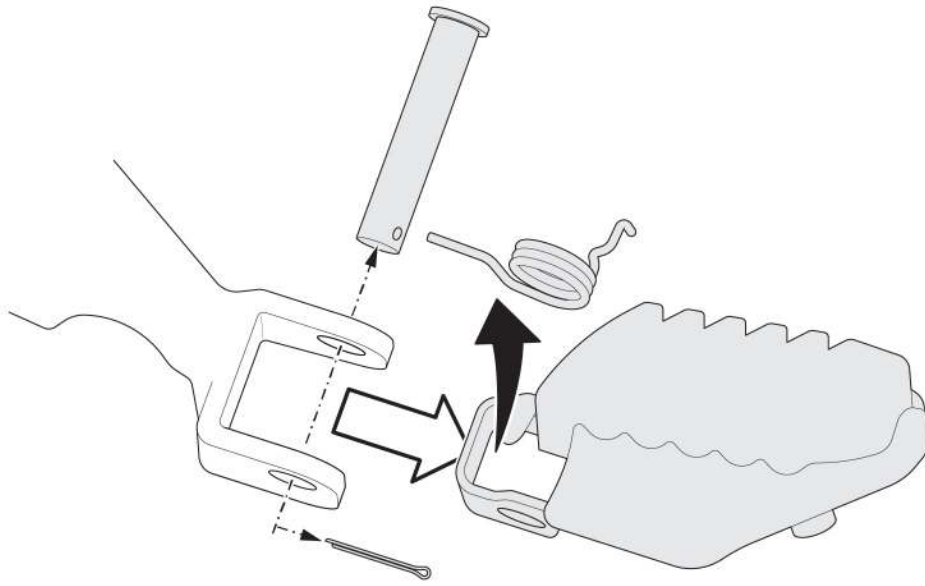

- ⚠ **WARNING:** Always wear eye and hand protection!
- ⚠ **WARNING:** Always use the proper tools!

⚠ **NOTE:** Mounting is identical on both sides.

⚠ **NOTE:** Before removing the original footrests, note the sequence and alignment of the original parts.

Remove the original footrests from **both sides**.



2

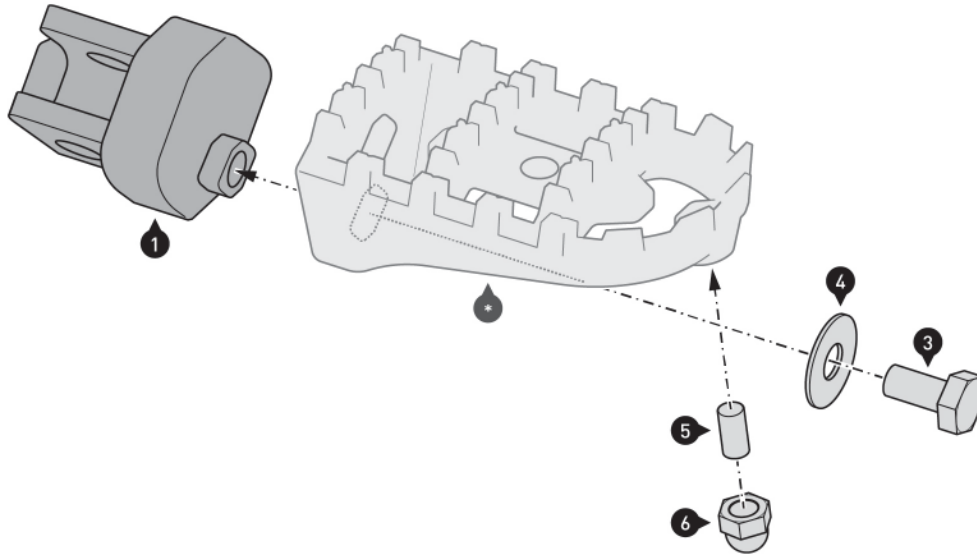
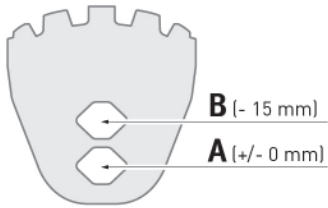

⚠ NOTE: The indicated part (*) is included with SW-MOTECH ION footrests (FRS.00.011.1000*/*).

Screw the footrests (*) to the joint adapters (1/2).

A = original position (± 0 mm).
B = lower position (- 15 mm).

⚠ WARNING: Use a liquid threadlocker!
Do not tighten the screws (3) yet.

Screw the threaded rods (5) to the ION footrests (*).

⚠ WARNING: Use a liquid threadlocker!
Tighten the threaded rods (5) and the nuts (6) as specified in the mounting instructions.

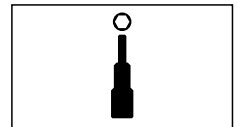
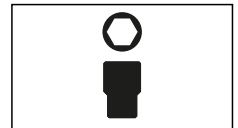
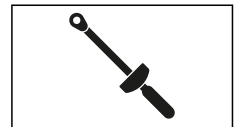
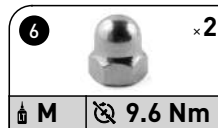

3

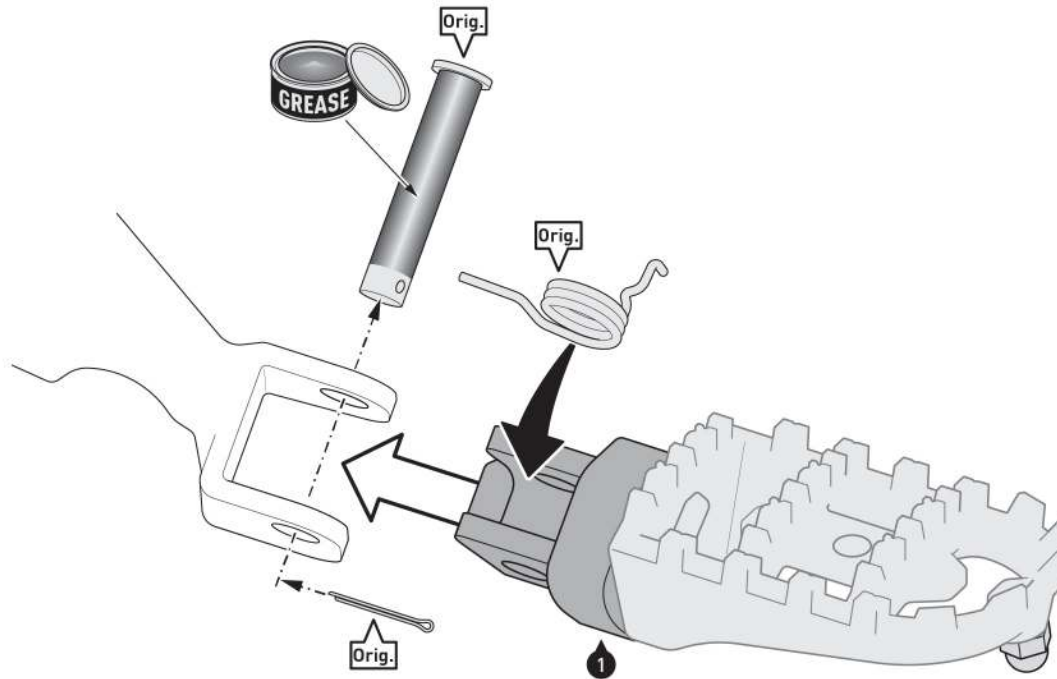

Clean the footrest mounts thoroughly. Apply rolling bearing grease to the original bolts (Orig.).

Install the joint adapters (1/2) with the original parts (Orig.) on **both sides** of the bike.
Tighten the screws (3) as specified in the mounting instructions.

PRODUCT-SPECIFIC NOTES

⚠ WARNING: This product may inhibit cornering and ground clearance in cases of extreme inclination!

⚠ NOTE: *Observe the country-specific regulations for the registration/operation of your vehicle or any applicable TÜV regulations. Have parts subject to registration entered in the vehicle documents by your inspection authority after installation.*

If a national type approval is available for this product:

You must always carry the national type approval supplied with the product with you! This national type approval only applies to the models listed and must comply with all requirements! For use with a vehicle not listed here, the entry must be made in the vehicle documents!

The vehicle assignments in the national type approval document are expanded annually. As a result, the national type approval for a new product may only take place a few months after the market launch. If your model is not listed or if you no longer have the national type approval document, please visit the Download section of our web shop. The current version of the national type approval document will be available there.

ION Fußrasten / ION footrests

Die Modellzuweisungen von diesem Artikel finden Sie auf unserer Website.
The application list for this product can be found on our website.

Montagehinweise

ACHTUNG: Die Montage dieses Produktes kann kompliziert sein und erfordert ein gutes technisches Verständnis. Wenn Sie unsicher sind, lassen Sie Montage und Wartung durch eine Fachwerkstatt durchführen. SW-MOTEC übernimmt keine Haftung für Schäden, die durch eine unsachgemäße Montage verursacht wurden.

Alle vom Motorrad gelösten Schrauben sind gemäß Herstellerangaben wieder zu montieren, oder mit von SW-MOTEC gelieferten Schrauben zu ersetzen. Falls nicht anderweitig definiert, diese Schrauben nach Tabelle anziehen:

M6	9,6 Nm
----	--------

Gegebenenfalls Schrauben mit flüssiger Schraubensicherung einkleben.

Prüfen Sie nach 50 km alle Verbindungen auf festen Sitz.

**Technische Änderungen vorbehalten.
Irrtümer ausgenommen.**

Mounting Instructions

ATTENTION: The assembly of this product can be complicated and requires a good technical understanding. If you are not sure of how to do this, have a specialty garage perform the mounting and service. SW-MOTEC accepts no liability for damages caused by improper installation.

All screws, bolts and nuts, including all replacement hardware provided by SW-MOTEC, should be tightened to the torque specified in the OEM maintenance manual for your motorcycle. If no torque specifications are provided in the OEM maintenance manual, the following torques may be used:

M6	9,6 Nm
----	--------

Medium strength liquid thread-locker should be used to secure all screws, bolts and nuts.

All screws, bolts and nuts should be checked after driving the first 50 km to ensure that all are tightened to the proper torque.

Subject to change. Not responsible for typos.

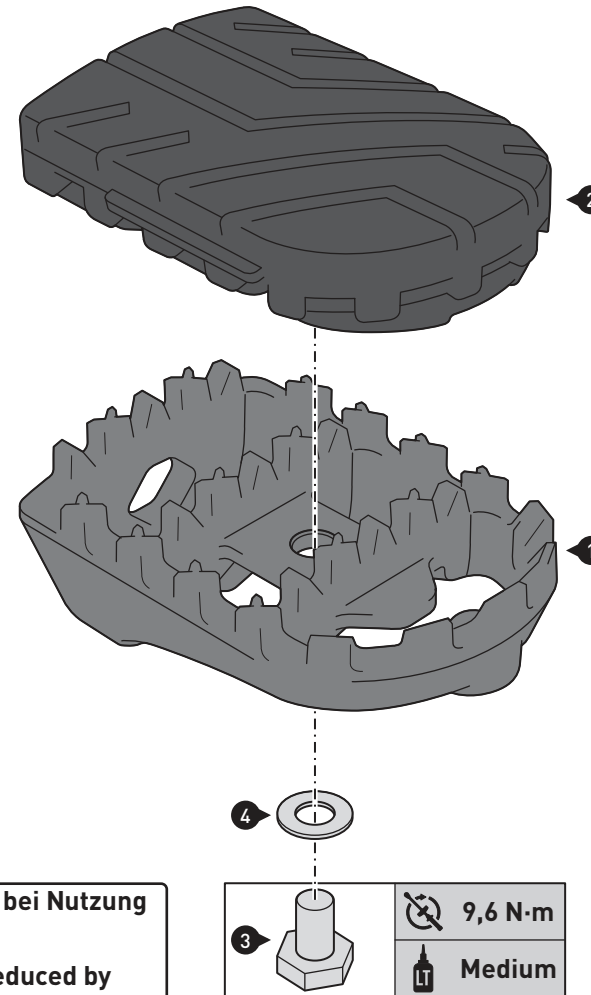

**WARNUNG
ATTENTION** Die Boden- und Schräglagenfreiheit kann bei Nutzung dieses Anbauteils eingeschränkt sein!
Cornering and ground clearance can be reduced by using this product!

INFORMATION Sofern für dieses Produkt eine Allgemeine Betriebserlaubnis (ABE) vorliegt: Die mit dem Produkt ausgelieferte ABE muss immer mitgeführt werden! Diese ABE gilt nur für die gelisteten Modelle und unter Beachtung aller Auflagen! Für eine Verwendung am hier nicht aufgeführten Fahrzeug muss die Eintragung in die Fahrzeugpapiere vorgenommen werden!
Die Fahrzeugzuweisungen im ABE-Dokument werden jährlich erweitert. Dadurch kann die ABE für ein neues Produkt unter Umständen erst einige Monate nach Markteinführung erfolgen. Wird Ihr Modell nicht aufgelistet oder sollte Ihnen das ABE-Dokument nicht mehr vorliegen, besuchen Sie bitte die Download-Sektion unseres Webshops. Dort steht Ihnen das ABE-Dokument in seiner jeweils aktuellen Version zur Verfügung.

SW-MOTEC GmbH & Co. KG
Ernteweg 7-10
35282 Rauschenberg
Germany

Tel. +49 (0) 64 25/8 16 8-050
Fax +49 (0) 64 25/8 16 8-10

info@sw-motech.com
www.sw-motech.com

1 Fußraste
Footrest

silbern/schwarz
silver/black
FRS.00.011.001 / .001.025
Anzahl/Pcs. 2

2 Profilgummi
Rubber Pad

FRS.00.011.002
Anzahl/Pcs. 2

3 Sechskantschraube
Hexagon Screw

M6 x 10; DIN 933
Anzahl/Pcs. 2

4 Unterlegscheibe
Washer

ø 6,4; DIN 125
Anzahl/Pcs. 2