

ANBAUANLEITUNG

mounting instructions • instructions de montage • instrucciones de montaje • istruzioni di montaggio

GPT.08.866.60001/B

beinhaltet • contains • contient • contiene • contiene

GPT.08.866.16001/B

BC.HTA.00.677.20000/B

Item number: **GPT.08.866.16001/B**

Revision: **00** · Date: **03 - 2026**

STREET-RACK

 ~ 0.75 h.

EASY     DIFFICULT

ENGLISH Thank you for choosing this premium product from SW-MOTECH. Visit our online shop for more information (e.g. model assignments). Required documents (e.g. national type approval) are available there for you to download.

Please read and understand all the instructions, safety information and warnings in these mounting instructions before mounting and using the product in order to avoid injury and damage. Keep these mounting instructions for reference.

This product was developed for vehicles in factory condition. Compatibility with original accessories or accessories from other manufacturers cannot be guaranteed.

These mounting instructions have been prepared to the best of our current knowledge. No legal claims relating to accuracy can be made. Errors and omissions excepted. We reserve the right to make technical and design changes. The copyright is held by SW-MOTECH.

SAFETY WARNING SYMBOL

 This warning symbol is used in these mounting instructions to warn of deadly dangers, injuries or other hazards. The words **DANGER**, **WARNING** or **CAUTION** are used as part of this warning symbol to convey important safety messages and information relating to the installation and use of this product. These words, together with the safety warning symbol, mean:

 **DANGER:** Indicates a hazardous situation which, if not avoided, will result in death or serious injury!

 **WARNING:** Indicates a hazardous situation which, if not avoided, may result in death or serious injury!

 **CAUTION:** Indicates a hazardous situation which, if not avoided, may result in minor or moderate injury!

 **NOTE:** Important information, but not relating to a risk of death or injury (property damage only)!

GENERAL INFORMATION

 **WARNING:** Assembly and/or maintenance of this product requires advanced technical skill, appropriate tools, and a good understanding of tool usage and torque specifications. For your own safety, SW-MOTECH recommends having the assembly and/or maintenance carried out by a qualified and certified motorcycle workshop.

 **WARNING:** If you do choose to assemble this product yourself, carefully and fully read the mounting instructions before assembly and use, and follow all instructions to avoid serious injury or death. Also observe all relevant information in the vehicle manual when mounting or using the product. IF YOU DO NOT UNDERSTAND ANY PART OF THESE MOUNTING INSTRUCTIONS OR NEED AN EXPLANATION AS TO A SPECIFIC INSTRUCTION, DO NOT ATTEMPT TO INSTALL THIS PRODUCT WITHOUT CONSULTING SW-MOTECH FOR ASSISTANCE!

PREPARATION: Read the mounting instructions carefully and make sure that all parts on the parts list are available.

 **CAUTION:** Ensure that your vehicle is standing securely. Switch off the engine and remove the ignition key. Allow the engine/exhaust to cool down if necessary. Disconnect the battery when working on the electrical system. Only use proper tools and always wear safety goggles and gloves during assembly and maintenance. Have a second person help you with assembly and maintenance.

ASSEMBLY: All parts and connections removed from the vehicle must be reinstalled according to the vehicle manufacturer's specifications or replaced with parts and hardware supplied by SW-MOTECH.

 **WARNING:** Secure all threads with a medium-strength liquid threadlocker, unless otherwise specified.

 **DANGER:** Tightening torques not defined by SW-MOTECH must be obtained from the vehicle manufacturer or a certified motorbike workshop.

FUNCTIONAL CHECK: After mounting the product, ensure that no moving parts are obstructed and that the function of the vehicle is not impeded. Cables and hoses must not rub against each other and/or be hindered in any way.

 **WARNING:** Carry out a comprehensive functionality check before you start to drive. Check the tightening torque of all connections and the tight fit of the product after the first 50 km and then at regular intervals. Mounted accessories can change the handling and stability of the vehicle.



SW-MOTECH GmbH & Co. KG
Ernteweg 7-10
35282 Rauschenberg
Germany



 info@sw-motech.com
 www.sw-motech.com



Take note of the symbols and what they mean in the ASSEMBLY section. If the term OEM appears in the ASSEMBLY section, the vehicle manufacturer's specifications must be observed and applied.



If you have any questions, please don't hesitate to contact our Customer Service team or our distributors. You can find our telephone number and a list of our distributors in our online shop:

www.sw-motech.com



Use thread locker: Indicates that a thread must be coated with liquid thread locker. H (HIGH): high strength; M (MEDIUM): medium strength; L (LOW): low strength.



Tighten/note the tightening torque information:

Indicates the tightening torque of a part specified by SW-MOTECH or the vehicle manufacturer (OEM).

PARTS LIST - READ AND KEEP MOUNTING INSTRUCTIONS!

2	<div data-bbox="150 150 359 371">  </div> <div data-bbox="150 371 359 454"> <p>GPT.08.866.901.02.11</p> <p> 1/1</p> </div>	<div data-bbox="359 150 584 371">  </div> <div data-bbox="359 371 584 454"> <p>GPT.08.866.902.02.11</p> <p> 1/1</p> </div>	<div data-bbox="584 150 809 371">  </div> <div data-bbox="584 371 809 454"> <p>KES.RD.210.0300.02.GL</p> <p> 4/4</p> </div>	<div data-bbox="809 150 1034 371">  </div> <div data-bbox="809 371 1034 454"> <p>M8 x 45; DIN 912 SC.ST.08.045.48.912.109</p> <p> 2/2</p> </div>	<div data-bbox="1034 150 1259 371">  </div> <div data-bbox="1034 371 1259 454"> <p>M8 x 35; DIN 912 SC.ST.08.035.02.912.109</p> <p> 2/2</p> </div>	<div data-bbox="1259 150 1505 371">  </div> <div data-bbox="1259 371 1505 454"> <p>ø 8,4; DIN 125 US.ST.084.02.125</p> <p> 4/4</p> </div>
	<div data-bbox="150 472 359 694">  </div> <div data-bbox="150 694 359 777"> <p>Ø 18 / ø 8,4 / h 15 DB.ST.0180.0084.0150.48</p> <p> 2/2</p> </div>	<div data-bbox="359 472 584 694">  </div> <div data-bbox="359 694 584 777"> <p>Ø 18 / ø 8,4 / h 25 DB.ST.0180.0084.0250.48</p> <p> 2/2</p> </div>				
3	<div data-bbox="150 795 359 1016">  </div> <div data-bbox="150 1016 359 1099"> <p>GPT.00.200.050.11</p> <p> 1/1</p> </div>	<div data-bbox="359 795 584 1016">  </div> <div data-bbox="359 1016 584 1099"> <p>M8 x 25; DIN 7991 SC.ST.08.025.02.7991.088</p> <p> 4/4</p> </div>	<div data-bbox="584 795 809 1016">  </div> <div data-bbox="584 1016 809 1099"> <p>ø 8,4 SE.00.084.02</p> <p> 4/4</p> </div>			

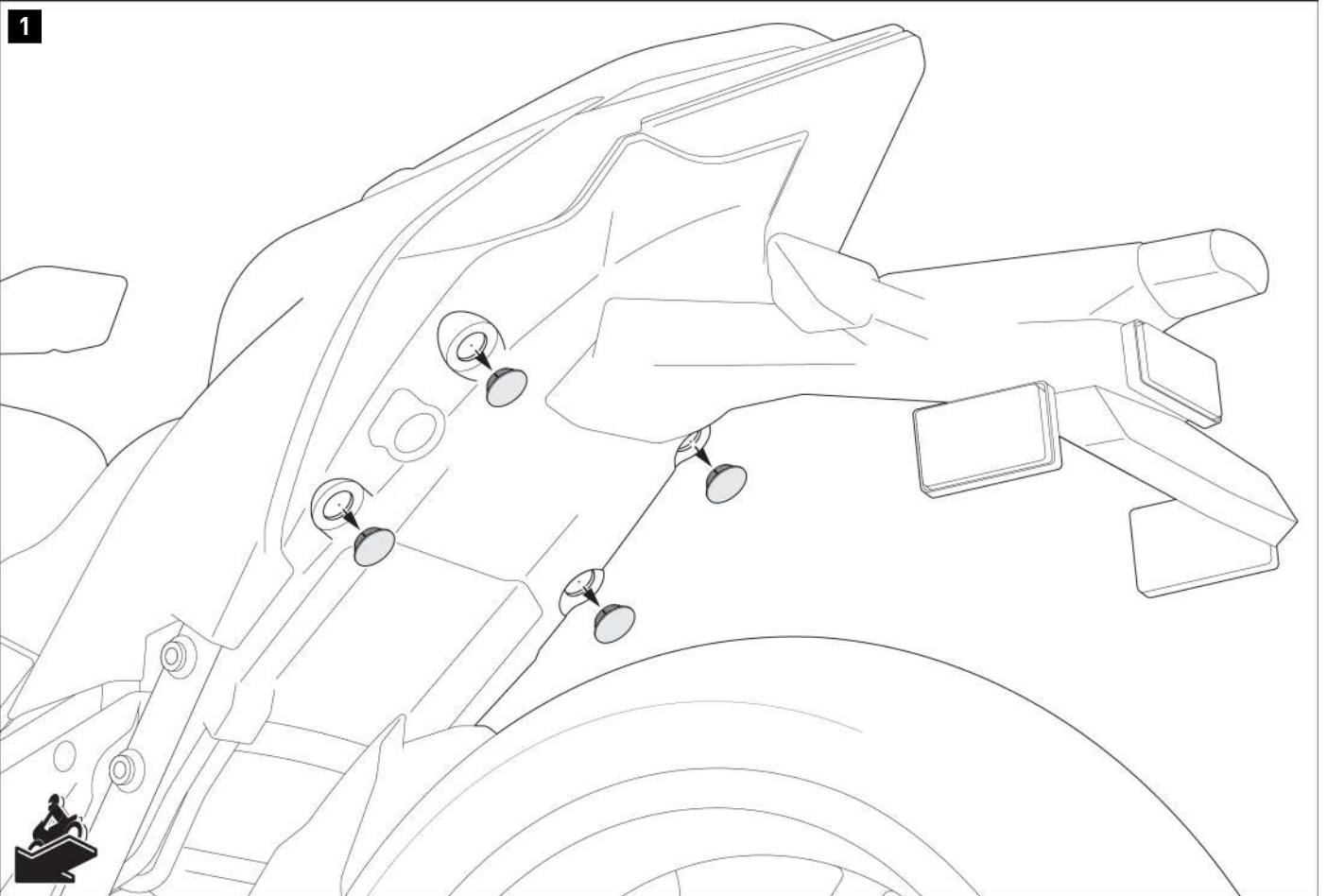

- ▲ **WARNING: Always wear eye and hand protection!**
- ▲ **WARNING: Always use suitable tools!**

Remove the plastic plugs from the vehicle.



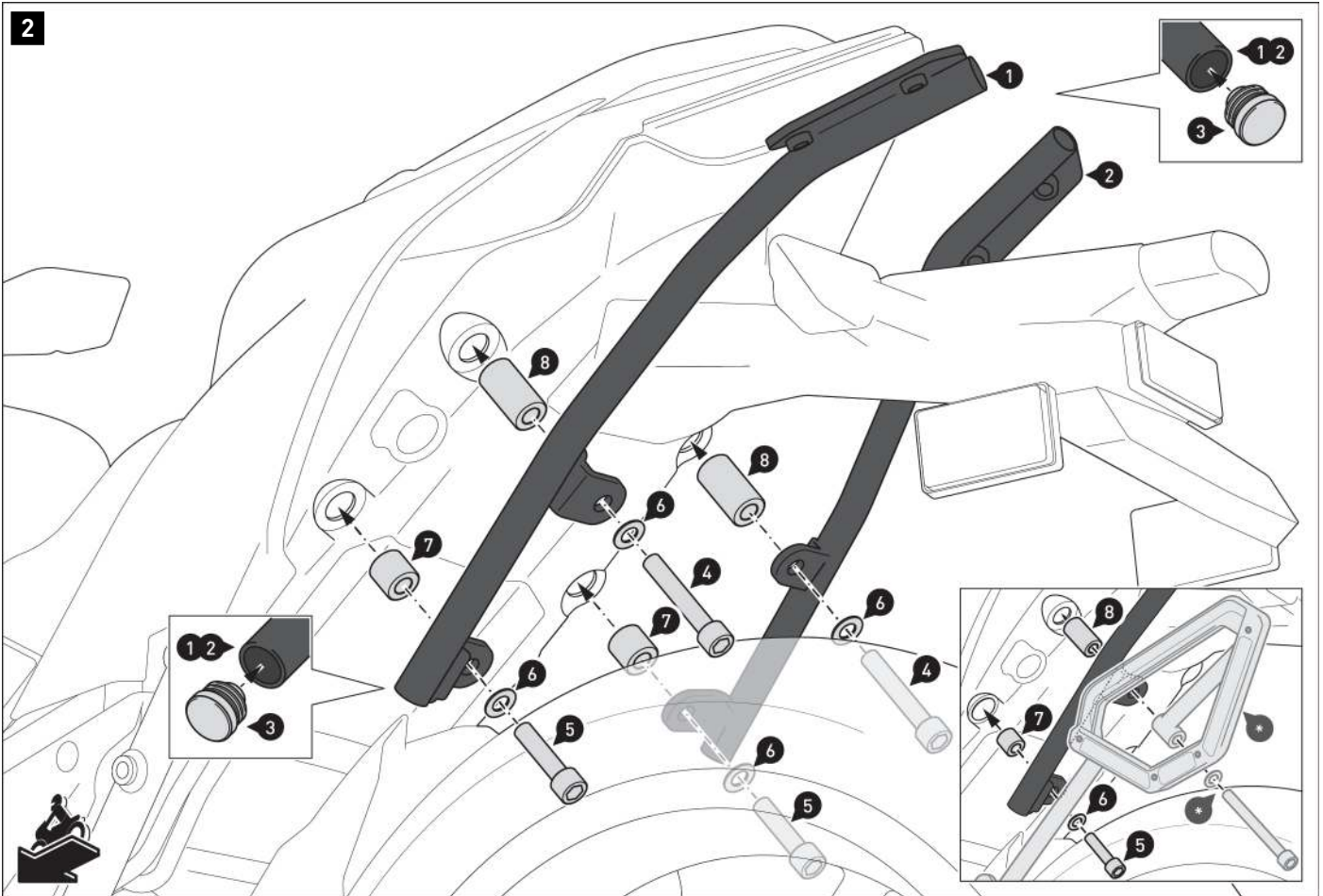

NOTE: The detailed drawing shows the installation of the luggage rack with the SW-MOTECH side carrier. Use the mounting parts included with the side carrier (-) in combination with the mounting parts shown for the luggage rack.

Insert the plastic plugs (3) into the ends of the mounting struts (1/2).

Screw the struts (1/2) to **both sides** of the vehicle.

WARNING: Use liquid threadlocker!
Do not tighten screws (4) and (5) yet.

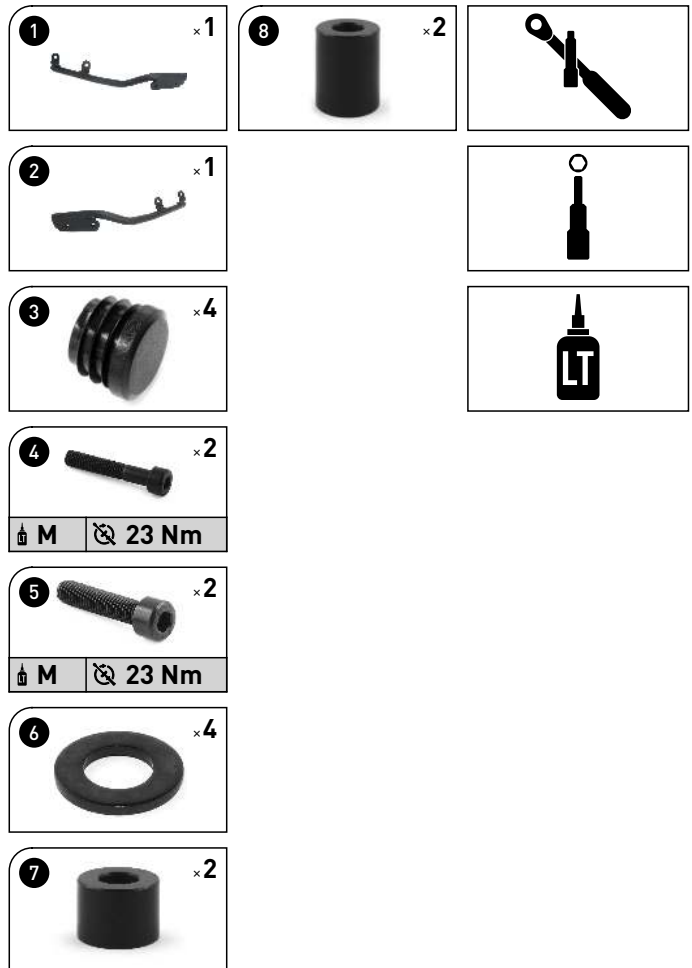

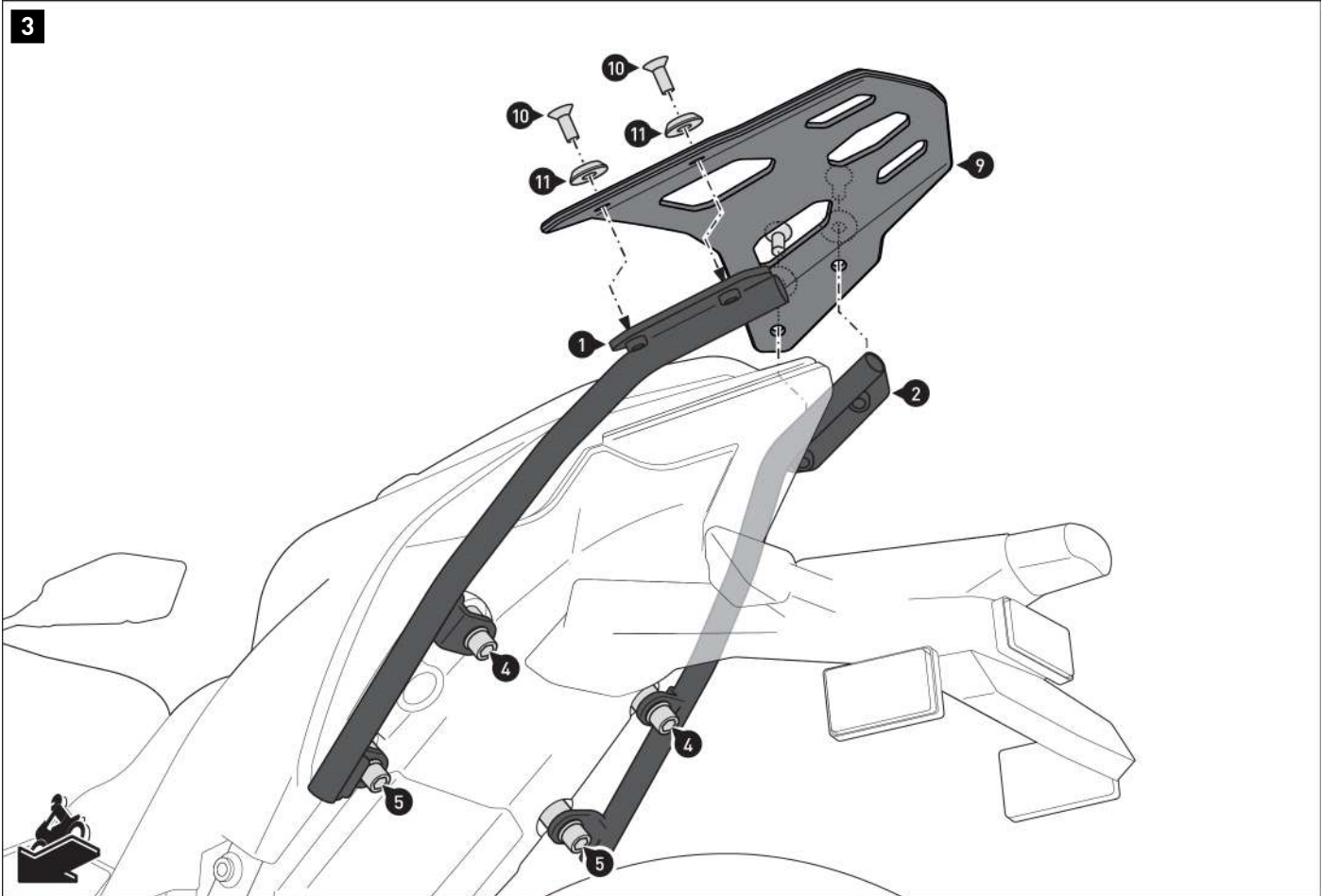

Screw the luggage rack (9) onto the mounting struts (1/2).

▲ WARNING: Use liquid threadlocker!

When all components are in place without tension, tighten screws (4), (5), and (10) as specified in the mounting instructions.

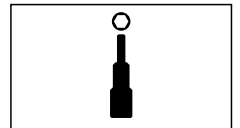
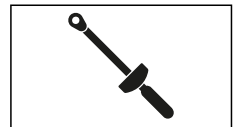

PRODUCT-SPECIFIC NOTES

⚠ WARNING: The specified maximum load includes the weight of the suitcase/luggage and adapter plate/adapter kit. The maximum load of the vehicle specified by the bike manufacturer applies.



≤ 7.5KG (≤ 16.5 lbs)



≤ 130 km/h (≤ 80 mph)

⚠ NOTICE: Observe all country-specific regulations for registering and operating your bike as well as the applicable TÜV requirements. After installation, have any registration-relevant parts entered into your vehicle documents by the local inspection authority.

Art.-Nr. / Item No.: **BC.HTA.00.677.21000/B & BC.HTA.00.677.22000/B**

Revision: **01** · Datum / Date: **06 - 2024**

URBAN ABS Topcase

URBAN ABS top case

DEUTSCH - Vielen Dank, dass Sie sich für dieses Premium-Produkt von SW-MOTECH entschieden haben. Bitte besuchen Sie unseren Webshop für weitere Informationen wie Modellzuweisungen und PDF-Anbauanleitung. Erforderliche Dokumente (z. B. ABE) stehen als Download zur Verfügung.

Die Montage und/oder Wartung dieses Produkts erfordert ein gutes technisches Verständnis! Zu Ihrer eigenen Sicherheit empfiehlt SW-MOTECH, die Montage und/oder Wartung durch eine Fachwerkstatt durchführen zu lassen! SW-MOTECH übernimmt keine Haftung für Schäden, die durch eine unsachgemäße Montage und/oder Wartung verursacht wurden!

Beachten Sie alle in der Anbauanleitung angegebenen Hinweise und die für die Montage relevanten Informationen im Fahrzeughandbuch. Nichtbeachtung kann zu Schäden am Fahrzeug bzw. zur Gefährdung des Fahrers führen! Diese Anbauanleitung ist nach unserem derzeitigen Kenntnisstand verfasst worden. Rechtliche Ansprüche auf Richtigkeit bestehen nicht.

Dieses Produkt wurde für Fahrzeuge im Werkzustand entwickelt. Die Kompatibilität mit Original-Zubehörteilen bzw. den Zubehörteilen anderer Hersteller kann nicht gewährleistet werden. Stellen Sie des Weiteren VOR Montage dieses Produkts sicher, dass sich alle beweglichen Teile (z. B. die Kette) im ursprünglichen Wartungszustand befinden. Montiertes Zubehör kann das Fahrverhalten und/oder die Stabilität Ihres Fahrzeugs verändern.

ALLGEMEINE HINWEISE

Beachten Sie die landesspezifischen Vorschriften für Zulassung / Betrieb Ihres Fahrzeugs bzw. anwendbare TÜV-Vorschriften. Lassen Sie eintragungspflichtige Teile nach Montage durch Ihre Prüfstelle in die Fahrzeugpapiere eintragen.

VORBEREITUNG: Lesen Sie die Anbauanleitung aufmerksam und stellen Sie sicher, dass alle Teile der Stückliste vorhanden sind. Achten Sie darauf, dass Ihr Fahrzeug sicher steht und nicht umfallen kann. Schalten Sie den Motor ab und ziehen Sie den Zündschlüssel. Lassen Sie ggf. den Motor / Auspuff abkühlen. Klemmen Sie bei Arbeiten an der Elektrik die Fahrzeugbatterie ab. Verwenden Sie geeignetes Werkzeug. Lassen Sie sich von einer zweiten Person helfen.

FUNKTIONSKONTROLLE: Da es sich um ein universelles Produkt handelt, stellen Sie unbedingt VOR der ersten Nutzung sicher, dass sich das Produkt ohne Probleme und sachgerecht an Ihrem Fahrzeugtyp befestigen und verwenden lässt. Achten Sie nach der Befestigung auf die uneingeschränkte Freigängigkeit und einwandfreie Funktion sämtlicher Fahrzeugteile. Leuchtmittel wie Rücklicht und Blinker dürfen nicht in ihrer Funktion eingeschränkt werden. Kabel, Züge und Schläuche dürfen nicht scheuern und/oder geklemmt werden. Führen Sie vor Fahrtbeginn eine umfassende Funktionskontrolle durch.

PRODUKTSPEZIFISCHE HINWEISE

ACHTUNG: Das Fahr-/Bremsverhalten des Motorrads verändert sich nach Befestigung dieses Produkts merklich!

ACHTUNG: Überprüfen Sie vor Fahrtbeginn und bei jeder Rast (alle 200 km) den ordnungsgemäßen Sitz des Produkts!

Maximale Zuladung	Höchstgeschwindigkeit
 7,5 KG (16,5 lbs)	 130 km/h (80 mph)

ACHTUNG: Die maximale Zuladung des verwendeten SW-MOTECH Gepäckträgers darf unter Berücksichtigung des Eigengewichts des Topcase (3 kg) NICHT überschritten werden (siehe Anbauanleitung des SW-MOTECH Gepäckträgers)! Es gilt die vom Fahrzeughersteller genannte maximale Zuladung des Fahrzeugs!

ACHTUNG 

NICHT FÜR DEN OFFROAD-EINSATZ GEEIGNET!

ENGLISH - Thank you for choosing this premium product from SW-MOTECH. Please visit our webshop for additional information, such as application charts and PDF mounting instructions. Any other documents that may be required (e.g. ABE certifications), are also available for download at our webshop.

Installation and/or maintenance of this product require good technical understanding! For your own safety SW-MOTECH recommends having installation and/or servicing carried out by a specialist workshop! SW-MOTECH assumes no liability for damage caused by improper installation and/or maintenance work!

Carefully follow all the directions given in the mounting instructions and pay attention to all relevant information in the vehicle manual during assembly. Nonconformance can lead to vehicle damage or even endanger the driver! These mounting instructions are written based on our current state of knowledge. Legal requirements for accuracy do not exist.

This product was developed for vehicles in their factory setting. Compatibility with original accessory parts or other manufacturers' accessory parts is not guaranteed. Furthermore, BEFORE installing this product, make sure that all moving parts (e.g. the chain) are in the original state of maintenance. Installed accessories can change the driving behaviour and/or stability of your vehicle.

GENERAL INFORMATION

Observe the country-specific regulations concerning vehicle registration / operation as well as TÜV regulations if applicable. If required, register installed parts in the vehicle documents through an appropriate inspection authority.

PREPARATION: Read the mounting instructions carefully and make sure that all items of the parts list are included. Make sure that your vehicle is parked safely and cannot fall over. Turn off the engine and remove the ignition key. Let the motor / exhaust cool off if necessary. Disconnect the vehicle battery when working on the electrical system. Use appropriate tools. Have another person to help you.

FUNCTION CHECK: This is a universal product. For this reason make sure BEFORE the first use, that the product can be fixed properly and used without problems with your vehicle type. After fixation also make sure that no moving parts are obstructed and the function of the vehicle is not hindered in any way. Lamps as taillight and turn signals must not be limited in their function. Cables and hoses must not rub and/or be pinched. Before starting to ride, perform a comprehensive check of all functions.

PRODUCT SPECIFIC INFORMATION

ATTENTION: Riding with this product may affect the motorcycles driving and braking performance!

ATTENTION: Before riding and at each stop (every 200 km) check proper fixation of the product!

Maximum Load	Maximum Speed
 7,5 KG (16,5 lbs)	 130 km/h (80 mph)

ATTENTION: The maximum load of the used SW-MOTECH luggage rack must not be exceeded (refer mounting instructions of the SW-MOTECH luggage rack); make sure to take into account the dead weight of the top case (3 kg)! The maximum vehicle load specified by the manufacturer must not be exceeded!

ATTENTION 

NOT FOR OFFROAD-USE!

Konfektionierung durch / Packed by:

Datum der Konfektionierung / Date of packaging:



SW-MOTECH GmbH & Co. KG
Ernteweg 8/10
35282 Rauschenberg
Germany

Tel. / phone + 49 (0)6425 / 8168 - 050
Fax / fax + 49 (0)6425 / 8168 - 10
info@sw-motech.com
www.sw-motech.com

STÜCKLISTE / PARTS LIST

Schritt Step	Nr. No.	Art.-Nr. / Bezeichnung * Item No. / Description *	Artikel	Part	Anzahl ** Quantity **	N-m ***	
			<i>Beide Varianten</i>	<i>Both variants</i>			
1	(1)		URBAN ABS Topcase	URBAN ABS top case	1 / 1		
	(2)	BC.ZUB.00.105.30000	Wasserdichte Innentasche	Waterproof inner bag	1 / 1		
	(3)	BC.LOC.00.001.10200/B	Motorradtaschen-Schloss	Lock for motorcycle luggage	1 / 1		
		BC.HTA.00.677.21000	URBAN ABS Topcase für STREET-RACK	URBAN ABS top case for STREET-RACK			
3	(4)	BC.HTA.00.677.500.01	Verschlussystem	Locking System	1 / 1		
	(5)	M5 x 12; ISO 7380	Linsenkopfschrauben; schwarz	Lenshead Screws; black	6 / 6	2,5	
	(6)	∅ 5,3; DIN 9021	Unterlegscheibe; Edelstahl	Washer; stainless steel	6 / 6		
	(7)	M5; DIN 985	Mutter, selbstsichernd; Edelstahl	Lock Nut; stainless steel	6 / 6		
7	(8)	HTA.00.864.500.07	Diebstahlsicherung	Anti-Theft Device	1 / 1		
	(9)	4,5 x 16	Linsenkopfschraube, gewindefurchend	Lenshead Screw, self-tapping	4 / 4	2,5	
		BC.HTA.00.677.22000	URBAN ABS Topcase als Verzurrvariante	URBAN ABS top case as lashing variation			
3	(4)	BC.HTA.00.677.900.01	Schaumgummiboden	Foam Rubber Base	1 / 1		
	(5)	M5 x 12; ISO 7380	Linsenkopfschrauben; schwarz	Lenshead Screws; black	6 / 8	2,5	
	(6)	∅ 5,3; DIN 9021	Unterlegscheibe; Edelstahl	Washer; stainless steel	6 / 6		
6	(7)	HTA.00.864.012	Abdeckplatte	Cover Plate	1 / 1		
	(8)	M5 x 12; ISO 7380	Linsenkopfschrauben; schwarz	Lenshead Screws; black	2 / 8	2,5	
	(9)	∅ 11 / ∅ 6 / h 4	Distanzbuchse; Kunststoff	Spacer; plastic	2 / 2		
	(10)	KEK.00.M8.ISK	Kunststoffkappe; schwarz	Plastic Cap; black	2 / 2		
7	(11)	BC.ZUB.00.097.30000	Schlaufgurt-Set (4 Stück)	Loop Strap Set (4 pieces)	1 / 1		
	(12)	BC.ZUB.00.004.30000	Verzurrösen-Set (2 Stück)	Lashing Eye Set (2 pieces)	1 / 1		
8.8	Regelgewinde / Coarse Thread ∅ M4 M5 M6 M8 M10 M12						10.9
	Stahl FK 8.8 / Steel CL 8.8 N-m 2,8 5,5 9,6 23 46 79						Stahl FK 10.9 / Steel CL 10.9 N-m 4,1 8,1 14 34 67 115

* Alle Maßangaben in Millimeter. - ** Der zweite Wert gibt die Gesamtanzahl des jew. Artikels in der Lieferung an.
 *** **Keine Anzugsmomentvorgabe: Verwenden Sie das vom Fzg.-Hersteller definierte Anzugsmoment!** Das Standard-Anzugsmoment der Tabelle kann verwendet werden, wenn es den Fzg.-Hersteller-Vorgaben entspricht.

* All measurements in millimeters. - ** The second number indicates the total quantity of the part in the delivery.
 *** **No torque specifications: Use the torque defined by vehicle manufacturer!** The standard torque in this table can be used as long as it is within the vehicle manufacturer's specifications.

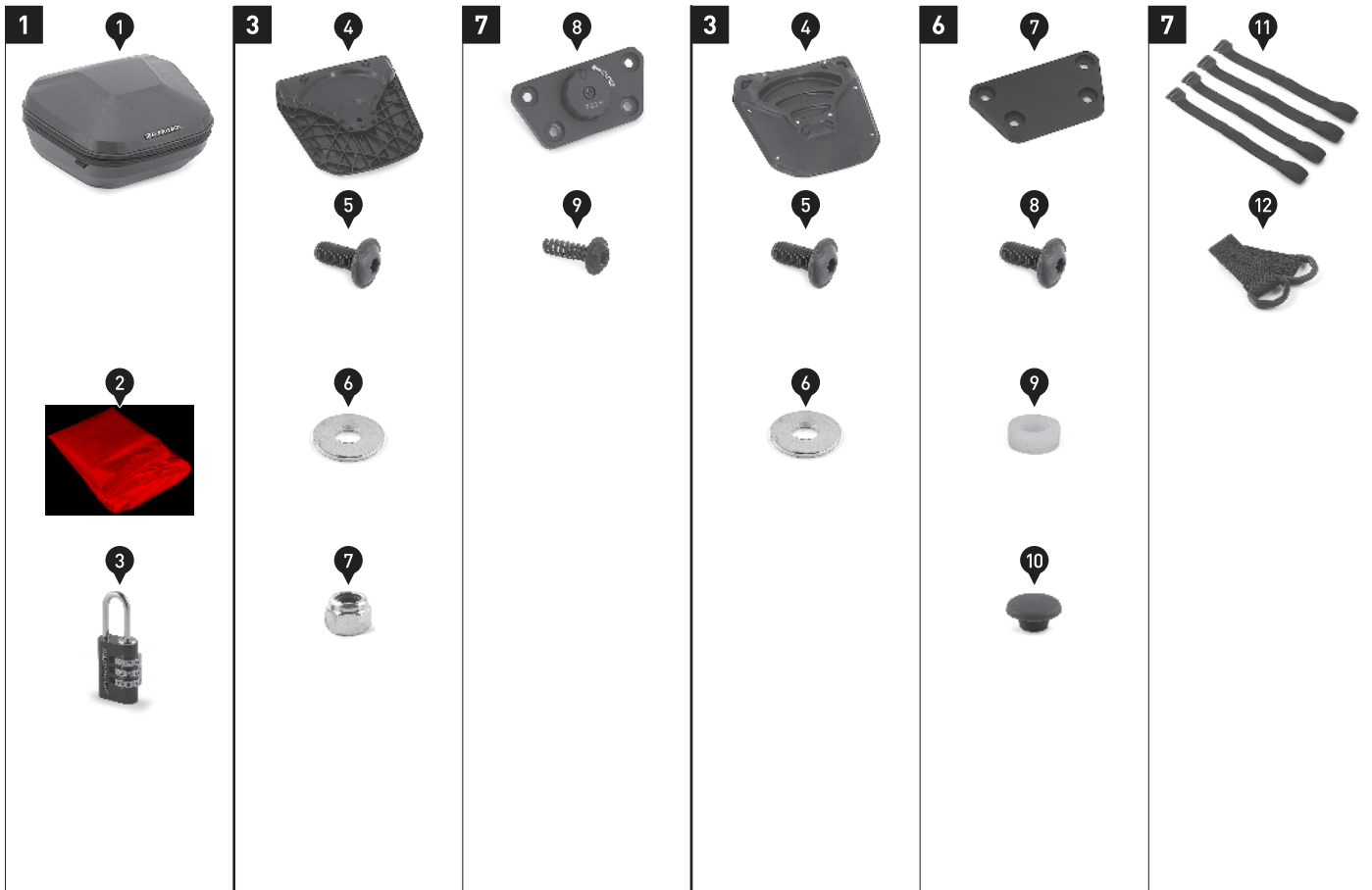

Seite 3 – 4:

URBAN ABS Topcase für STREET-RACK

Schritt [1]: Öffnen Sie den Deckel und den innenliegenden Reißverschluss des Topcase (1).

Schritt [2]: Klappen Sie die Innenverkleidung nach oben.

Schritt [3]: Verschrauben Sie das Verschlusssystem (4) unter dem Topcase (1). Achten Sie auf die Position des Verschlusshebels (geschlossen). Ziehen Sie die Schrauben wie in der Stückliste vorgegeben an.

Page 3 – 4:

URBAN ABS top case for STREET-RACK

Step [1]: Open the lid and inner zipper of the top case (1).

Step [2]: Flip up the inner lining.

Step [3]: Attach the locking system (4) under the top case (1). Pay attention to the position of the locking lever (closed). Tighten the screws as specified in the parts list.

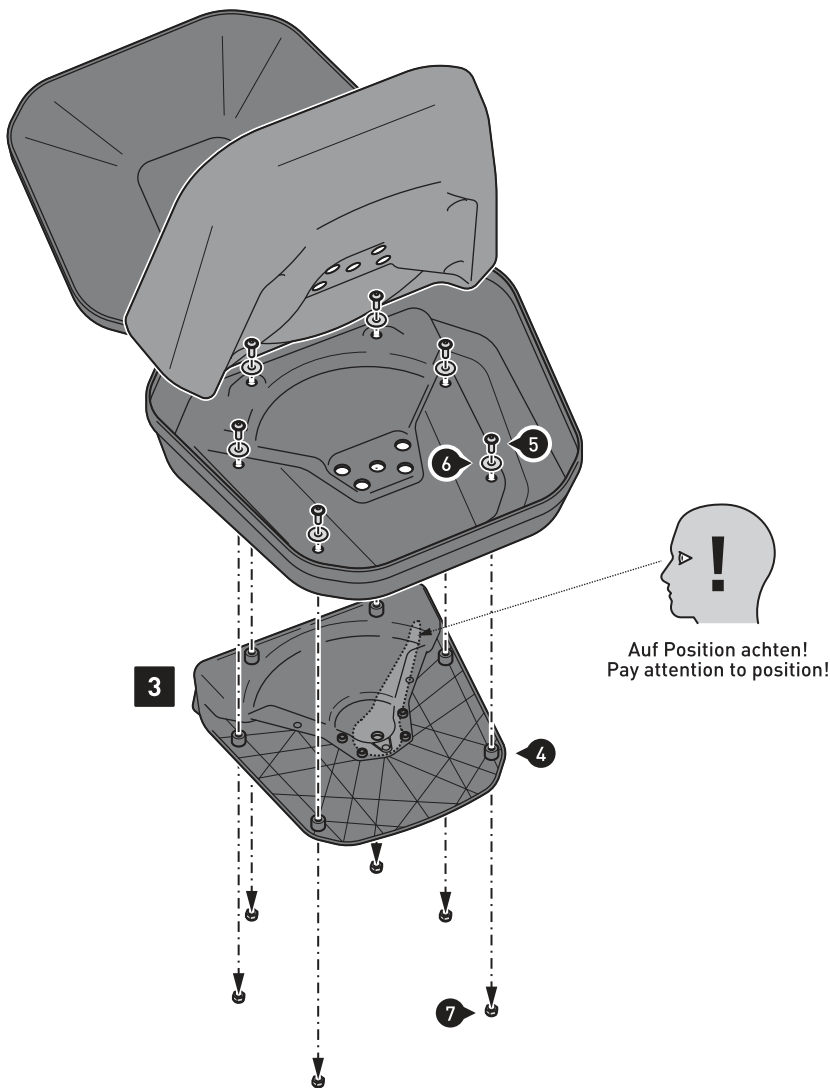
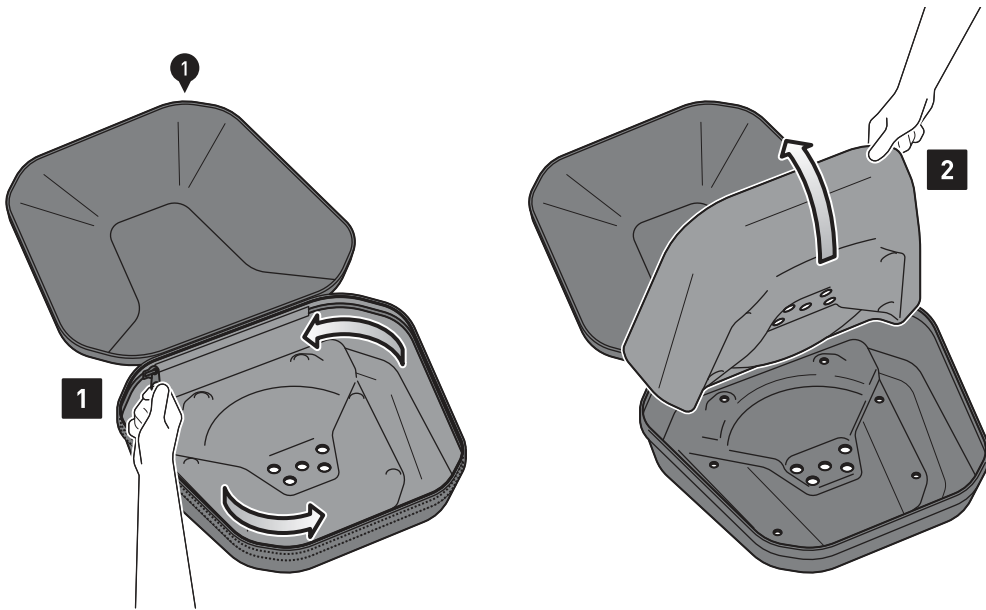

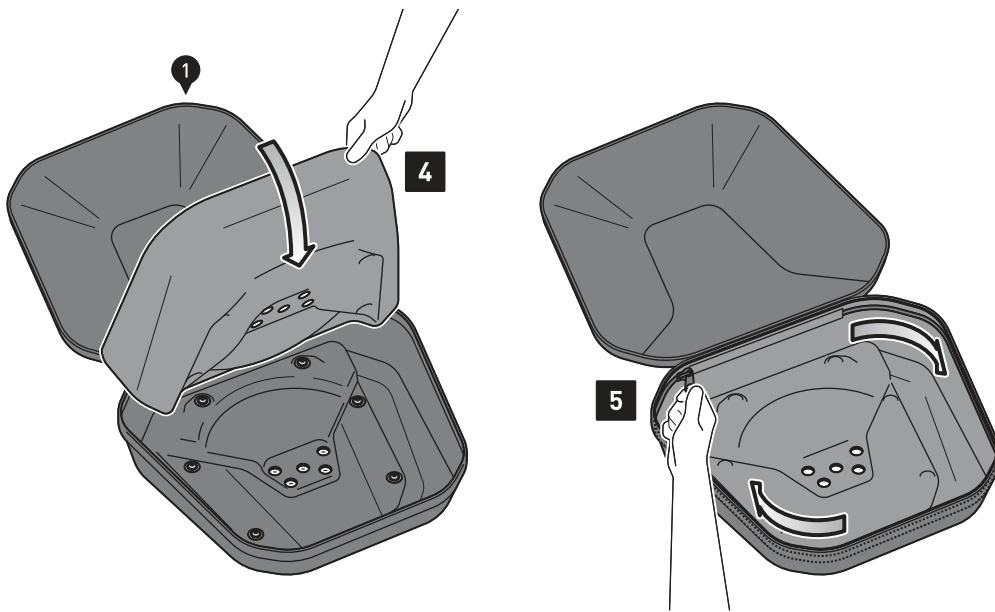

- Schritt [4]:** Klappen Sie die Innenverkleidung nach unten.
- Schritt [5]:** Schließen Sie den innenliegenden Reißverschluss des Topcase (1).
- Schritt [6]:** Drehen Sie den Sicherungsknopf der Diebstahlsicherung (8) in die geschlossene Position.
- Schritt [7]:** Verschrauben Sie die Diebstahlsicherung (8) im Topcase (1). Ziehen Sie die Schrauben wie in der Stückliste vorgegeben an.

BEFESTIGUNG AM STREETRACK GEPÄCKTRÄGER

- Schritt [8]:** Drehen Sie den Sicherungsknopf in die geöffnete Position.
- Schritt [9]:** Drücken Sie den Verschlusshebel in die geöffnete Position.
- Schritt [10]:** Schieben Sie das Verschlusssystem (4) mit den beiden Haken in die Öffnungen Ihres STREET-RACK Gepäckträgers [separat erhältlich].
- Schritt [11]:** Drücken Sie das Topcase (1) leicht nach unten ...
- Schritt [12]:** ... und schließen Sie den Verschlusshebel. Achten Sie auf das deutliche Einrastgeräusch.
- Schritt [13]:** Sichern Sie das Topcase mit dem Sicherungsknopf der Diebstahlsicherung (8) gegen Diebstahl und überprüfen Sie den festen Sitz am Fahrzeug.
- TIPP:** Wir empfehlen, den Sicherungsknopf der Diebstahlsicherung (8) während der Fahrt immer in der abgeschlossenen Position zu belassen.



Auf Position achten!
Pay attention to position!

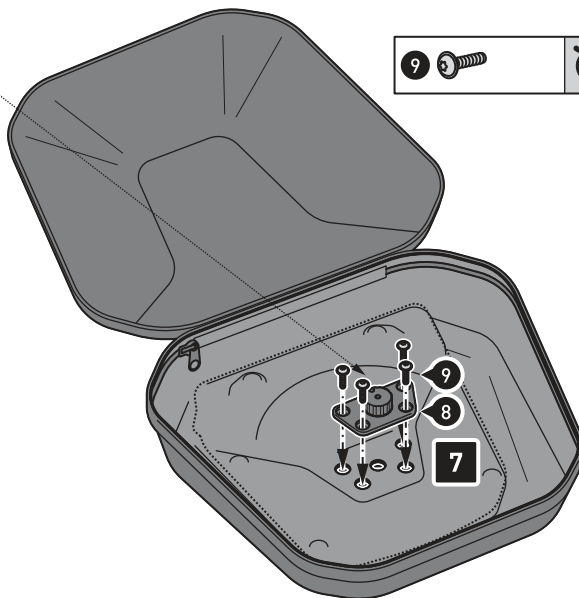
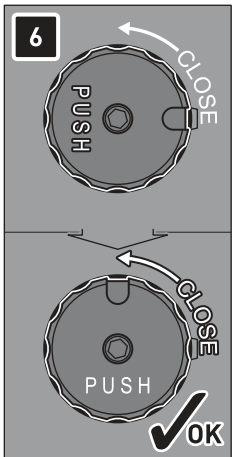

- Step [4]:** Flip down the inner lining.
- Step [5]:** Close the inner zipper of the top case (1).
- Step [6]:** Turn the locking button of the anti-theft device (8) to the closed position.
- Step [7]:** Attach the anti-theft device (8) inside the top case (1). Tighten the screws as specified in the parts list.

MOUNTING TO THE STREET-RACK

- Step [8]:** Turn the locking button into the open position.
- Step [9]:** Push the locking lever into the open position.
- Step [10]:** Slide the locking system (4) into the openings of your STREET-RACK [sold separately].
- Step [11]:** Press the top case (1) slightly down ...
- Step [12]:** ... and close the locking lever. Pay attention to the audible snap sound.
- Step [13]:** Secure the top case via locking button of the anti-theft device (8) against theft and check the proper fit on the vehicle.
- TIP:** We recommend leaving the locking button of the anti-theft device (8) in the closed position during the ride.

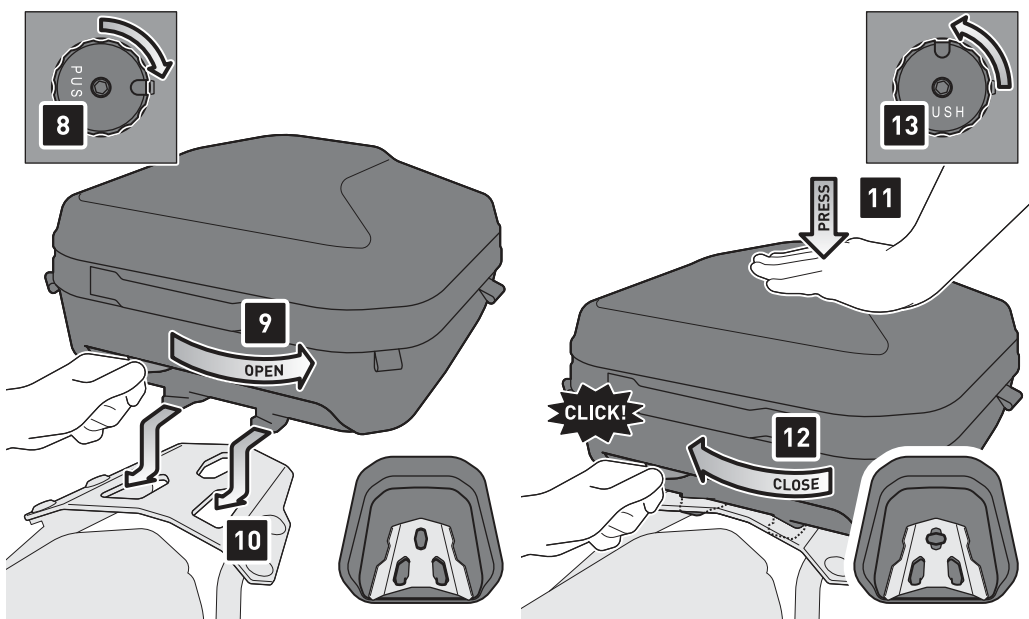

Seite 5 – 7:

URBAN ABS Topcase als Verzurrvariante

Schritt [1]: Öffnen Sie den Deckel und den innenliegenden Reißverschluss des Topcase (1).

Schritt [2]: Klappen Sie die Innenverkleidung nach oben.

Schritt [3]: Verschrauben Sie den Schaumgummiboden (4) unter dem Topcase (1). Ziehen Sie die Schrauben wie in der Stückliste vorgegeben an.

Schritt [4]: Klappen Sie die Innenverkleidung nach unten.

Schritt [5]: Schließen Sie den innenliegenden Reißverschluss des Topcase (1).

Page 5 – 7:

URBAN ABS top case as lashing variation

Step [1]: Open the lid and inner zipper of the top case (1).

Step [2]: Flip up the inner lining.

Step [3]: Attach the foam rubber base (4) under the top case (1). Tighten the screws as specified in the parts list.

Step [4]: Flip down the inner lining.

Step [5]: Close the inner zipper of the top case (1).

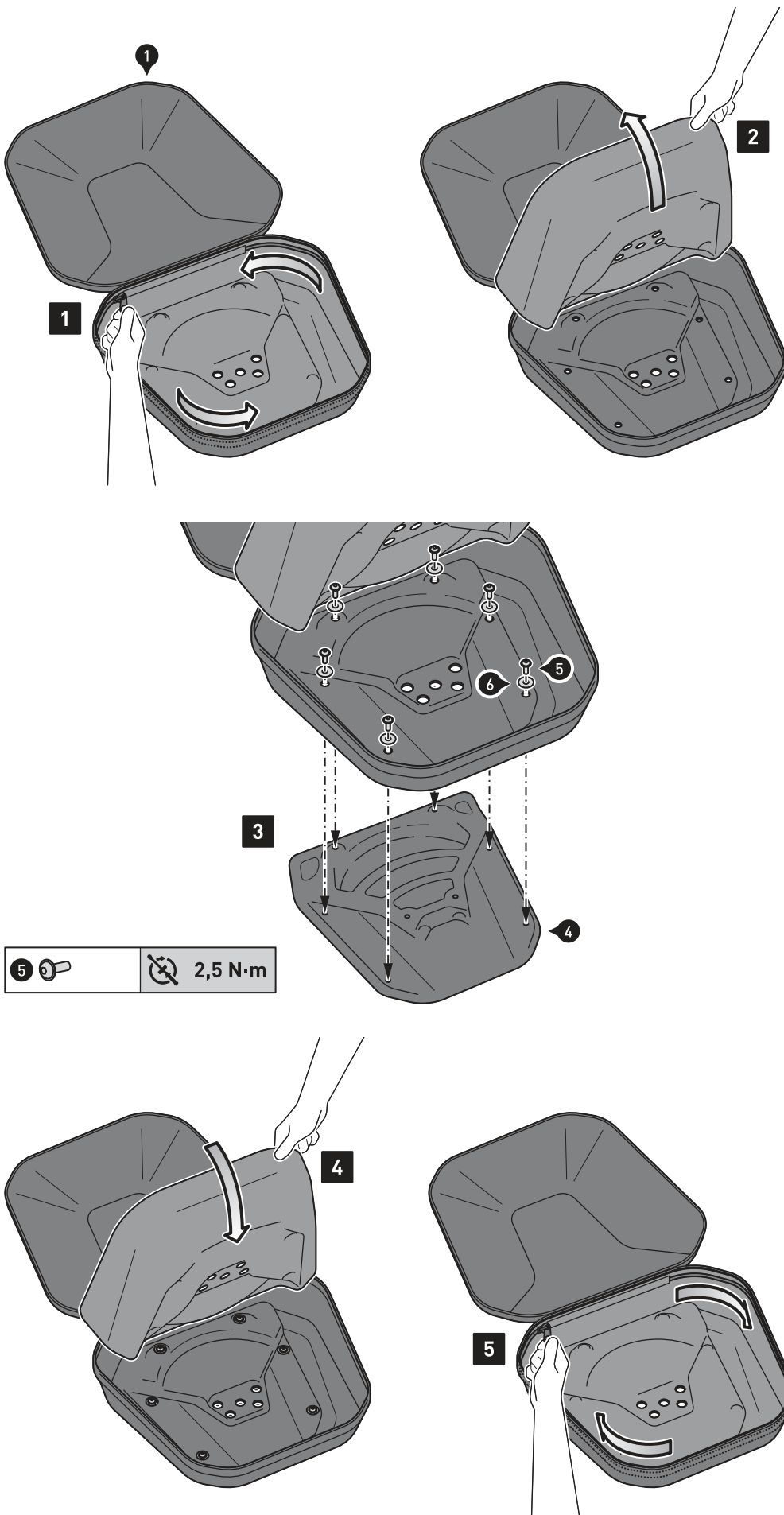

5 2,5 N-m

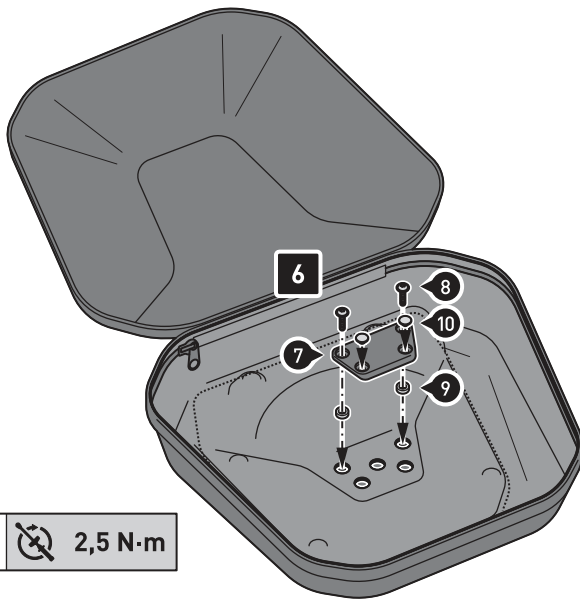

8 2,5 N·m

Schritt [6]: Verschrauben Sie die Abdeckplatte (7) im Topcase (1). Ziehen Sie die Schrauben wie in der Stückliste vorgegeben an.

BEFESTIGUNG AM FAHRZEUG

Schritt [7]: Verschlaufen Sie ZWEI Schlaufgurte (11) beidseitig an geeigneten und belastbaren Befestigungspunkten im Heckbereich des Fahrzeugs [z. B. Gepäckhaken etc.]. Verschlaufen Sie anschließend ZWEI Schlaufgurte (11) beidseitig an geeigneten und belastbaren Befestigungspunkten des Fahrzeugs [z. B. Fußrastenaufnahme, Fahrzeugrahmen etc.].

FUNKTIONSKONTROLLE (UNBEDINGT BEACHTEN)

ACHTUNG: Achten Sie nach der Befestigung darauf, dass kein Schlaufgurt mit heißen und beweglichen Teilen des Fahrzeugs in Berührung kommen kann. Achten Sie des Weiteren darauf, dass alle Schlaufgurte mindestens 15 cm Abstand zu heißen Teilen sowie dem heißen Abgasstrom des Auspuffs haben. Federn Sie zu diesem Zweck nach erfolgter Montage das Fahrzeug mehrere Male im Stand voll durch.

Step [6]: Attach the cover plate (7) inside the top case (1). Tighten the screws as specified in the parts list.

FIXATION TO THE VEHICLE

Step [7]: On both sides entangle TWO loop straps (11) to appropriate and reliable attachment points in the rear area of the vehicle (e.g. luggage hook etc.). Then entangle on both sides TWO loop straps (11) to appropriate and reliable attachment points of the vehicle (e.g. vehicles frame, footrest mounts etc.).

FUNCTION CHECK (MUST BE OBSERVED)

ATTENTION: All loop straps must not contact any hot or moving parts of the vehicle. All loop straps should also remain 15 cm away from hot parts of the vehicle and remain clear of the exhaust stream. For this reason compress the suspension fully several times with your vehicle stationary.

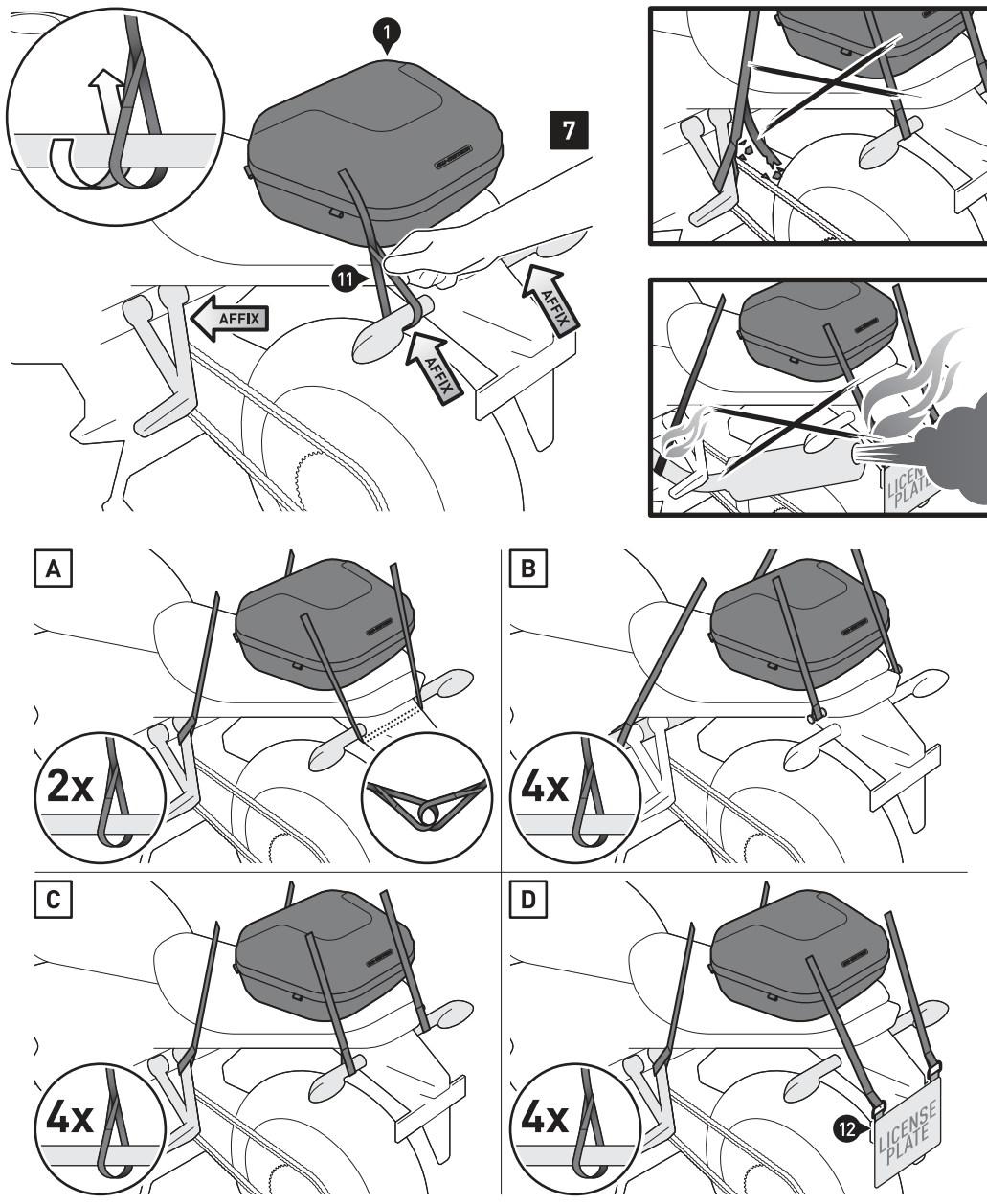

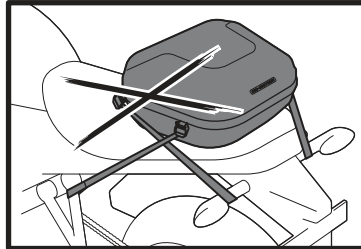
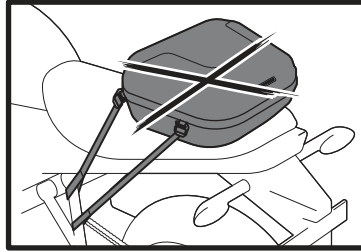
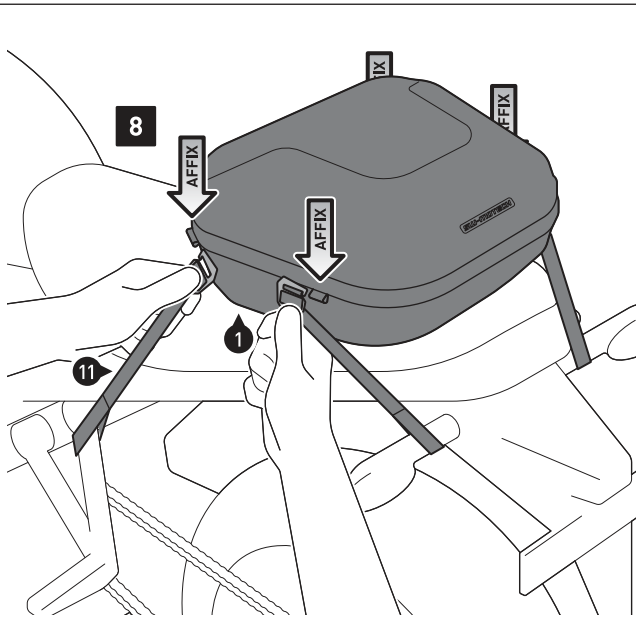

Schritt [8]: Befestigen Sie nun die Hakenschnallen der VIER Schlaufgurte (11) beidseitig an den in der Zeichnung gezeigten Schlaufen des Topcase (1). Ziehen Sie alle Befestigungsgurte an, bis das Topcase (1) zentriert und fest am Fahrzeug befestigt ist.

Schritt [9]: Sichern Sie die Überlängen der Schlaufgurte (11) mit den Gummischlaufen gegen Flattern.

Schritt [10]: Überprüfen Sie den festen Sitz des Topcase.

Step [8]: Attach the hook buckles of the loop straps (11) on both sides to the marked loops of the top case (1), as shown in the drawing. Tighten all loop straps until the top case (1) is centered and securely fastened to the vehicle.

Step [9]: Secure the overlength of the loop straps (6) with the rubber loops against flapping.

Step [10]: Check the proper fit of the top case.

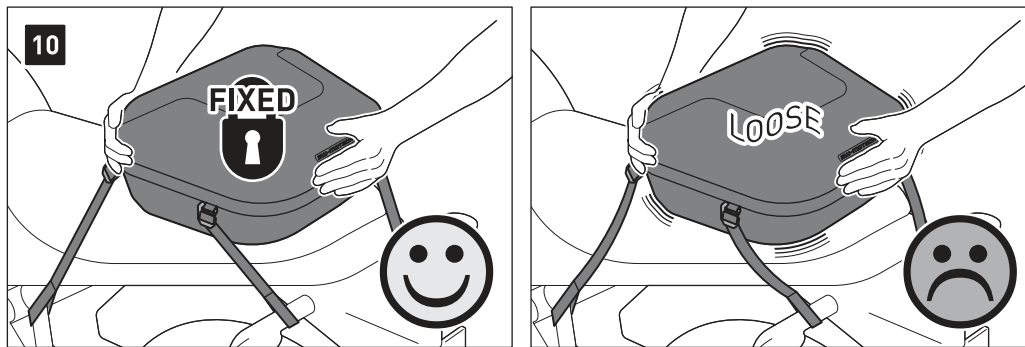
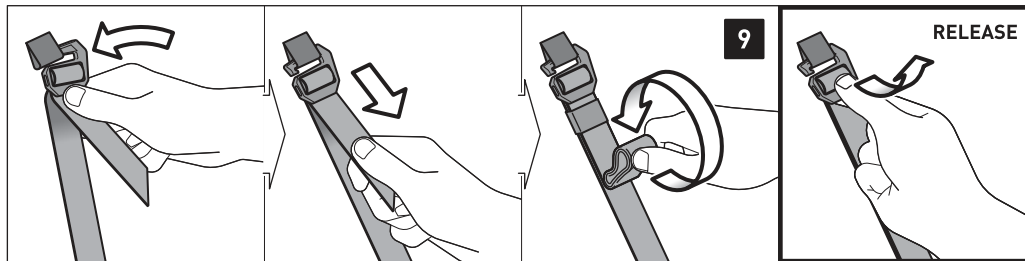

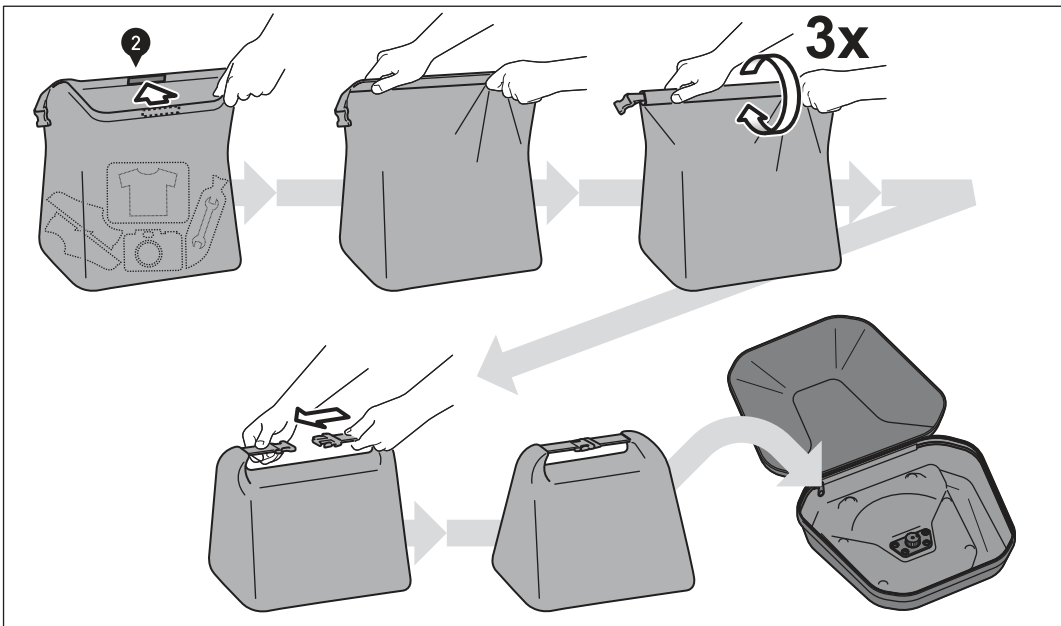

FEUCHTIGKEITSSCHUTZ

Verwenden Sie die beiliegende wasserdichte Innentasche (2), um Ihr Gepäck vor Feuchtigkeit zu schützen.

MOISTURE PROTECTION

Use the included waterproof inner bag (2) to protect your luggage from moisture.

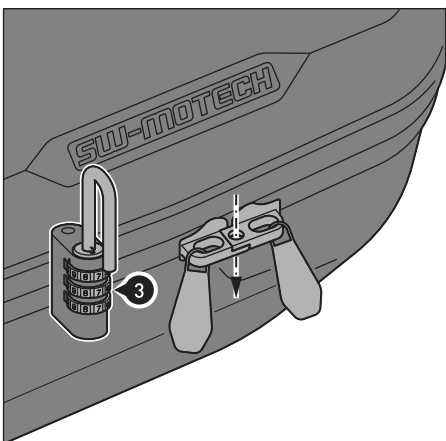

SICHERUNG

Verriegeln Sie die Puller des geschlossenen Reißverschlusses mit dem beiliegenden Schloss (3).

SECURITY

Lock the closed zipper with the included lock (3).



BELADUNG

ACHTUNG: Achten Sie darauf, niemals scharfkantige, spitze oder ähnliche Gegenstände zu verstauen, welche Verletzungen an Personen bzw. Beschädigungen am Fahrzeug/Topcase verursachen könnten!

Volumenerweiterung: Öffnen Sie den umlaufenden Reißverschluss. Der Öffnungswinkel kann für einen festen Sitz über die angebrachten Riemen reguliert werden.

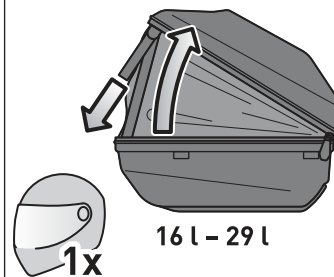

LOADING

ATTENTION: Never store pointy or sharp-edged objects, which could cause injury to persons or damage to the vehicle/top case.

Volume expansion: Open the revolving zipper. For a tight fit the opening angle can be adjusted via the attached straps.

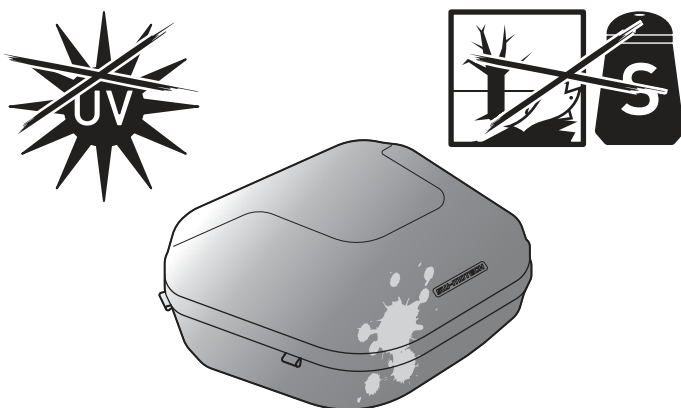

ACHTUNG: Oberflächenmaterialien können bei längerer und intensiver Sonneneinstrahlung und Umwelteinflüssen (z. B. SMOG, saurer Regen, etc.) Farbveränderungen (Ausbleichen) unterliegen! Dafür übernimmt SW-MOTECH keine Haftung!

ATTENTION: Surface materials can experience color changes or fading when exposed to direct sunlight for extended periods of time and by environmental factors (e.g., SMOG, acid rain, etc.)! SW-MOTECH assumes no liability for this!



PFLEGE

Verwenden Sie zur Reinigung NUR eine weiche Textilbürste, ein Tuch oder Schwamm und warme Seifenlauge! Spülen Sie anschließend mit klarem Wasser nach.

Verwenden Sie KEINE scharfen Reinigungsmittel, raue Putzutensilien oder einen Hochdruckreiniger! Reinigen Sie das Topcase unbedingt nach Winterfahrten, um Schäden durch das Salz zu vermeiden.



CARE

For cleaning use ONLY a soft textile brush, cloth or sponge and warm soapy water! Rinse with clean water.

Do NOT use strong cleaning agents, rough cleaning tools or high pressure washer! Clean the top case after riding in salty conditions, to avoid damage from salt.